

STAR WARS[®]

Cracken's Rebel Field Guide

A Supplement for use with *Star Wars: The Roleplaying Game*

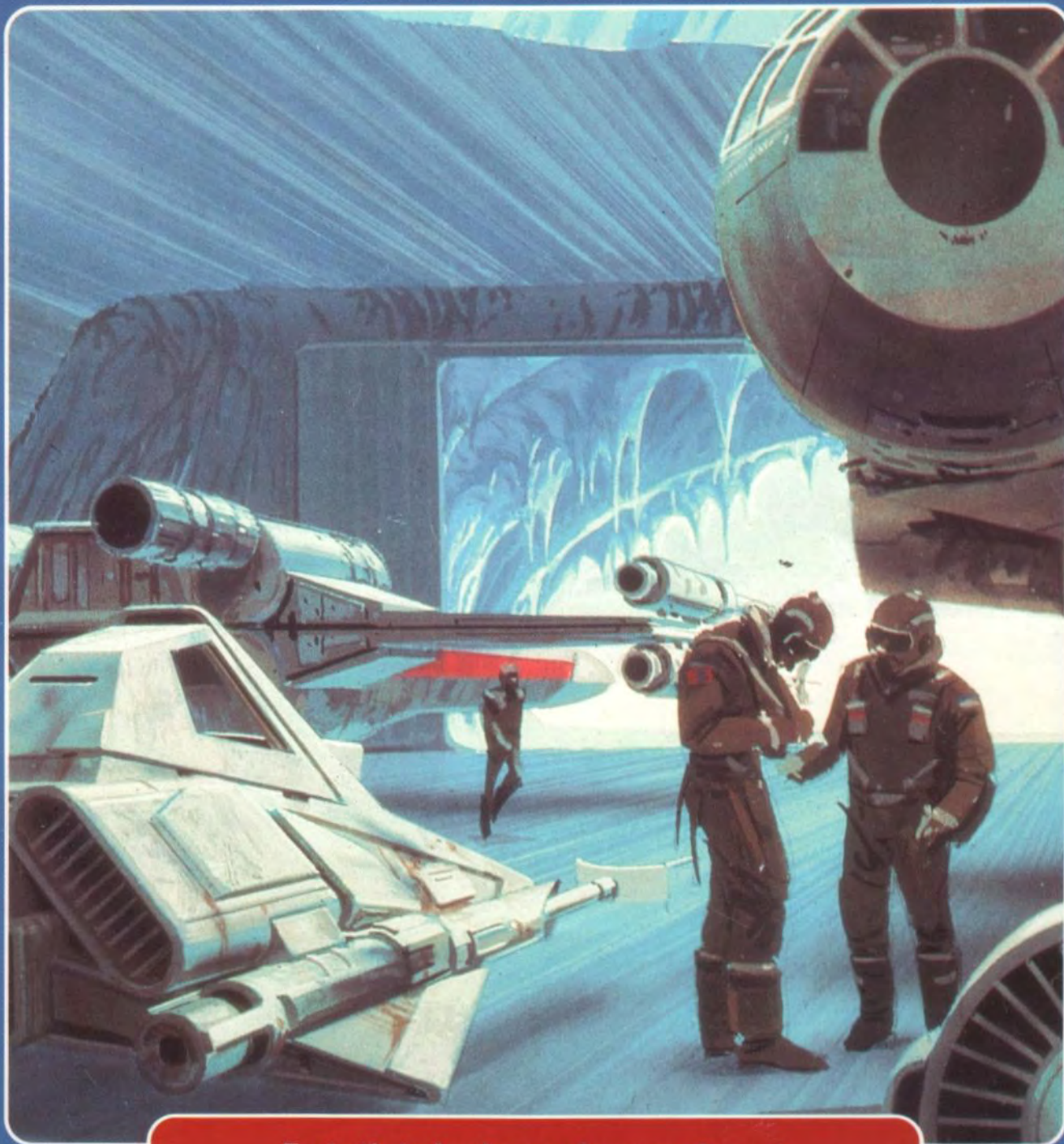

Fantastic technology and new equipment
to give the soldiers of the Rebel Alliance an edge in
their struggle against the Evil Galactic Empire.

**WEST
END
GAMES[®]**

STAR WARS®

Cracken's Rebel Field Guide

By Christopher Kubasik

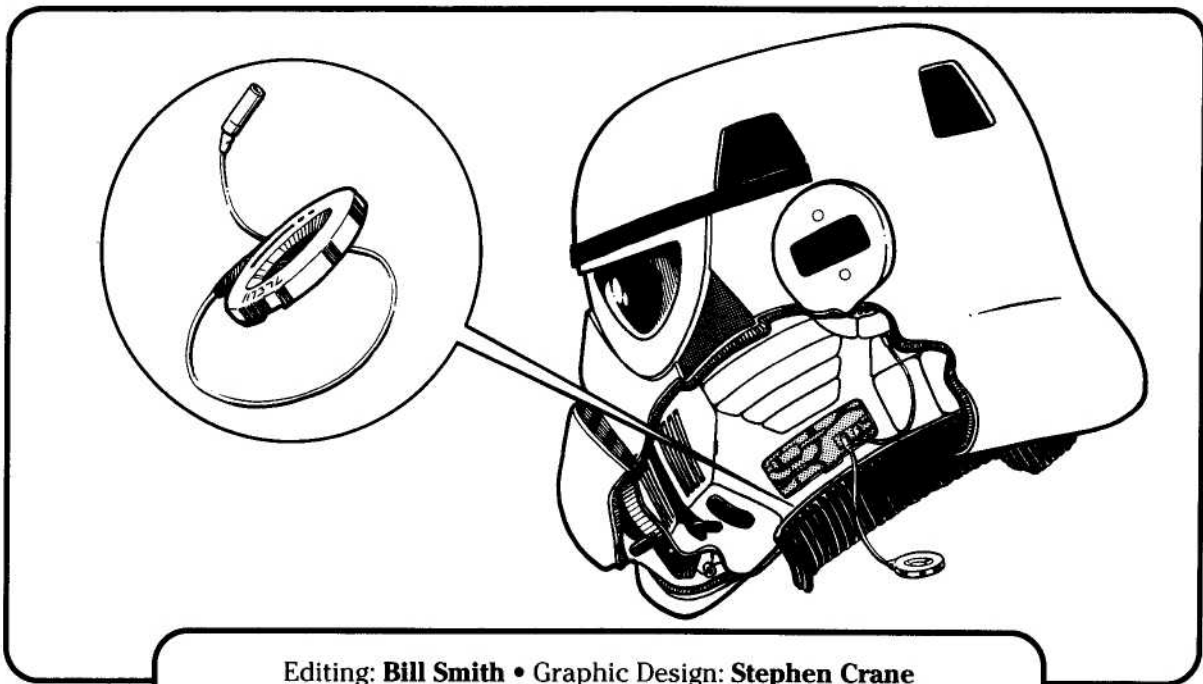

Editing: **Bill Smith** • Graphic Design: **Stephen Crane**
Graphics: **Stephen Crane, Richard Hawran** • Cover Art: **Ralph McQuarrie** • Interior Illustrations: **Rob Caswell, Stephen Crane, Mike Jackson, James B. King, John Paul Lona, Allen Nunis**

Publisher: **Daniel Scott Palter** • Associate Publisher: **Richard Hawran**
Associate Editor: **Greg Gorden** • Editor: **Greg Farshtey** • Assistant Editors: **Bill Smith, Ed Stark**
Art Director: **Stephen Crane** • Graphic Artists: **Cathleen Hunter, Allen Nunis**
Sales Manager: **Fitzroy Bonterre** • Sales Assistant: **Marla Kammeler-Kean**
Special Projects Manager: **Ron Selden** • Warehouse Manager: **Ed Hill**
Treasurer: **Janet Riccio**

Published by



RD3 Box 2345
Honesdale PA 18431

40046

Introduction

Cracken's Rebel Field Guide is a supplement for *Star Wars: The Roleplaying Game*. The marvelous technology of the *Star Wars* universe is one of the great curiosities for gamemasters and players. This book contains many new items for *Star Wars* adventures, and explains how inhabitants of the universe alter and manipulate that technology. New areas discussed include jury-rigged items, computer data and cybernetic technology.

This supplement is presented courtesy of General Airen Cracken, one of the many people who have devoted long years to the cause of the Rebel Alliance. Cracken's field experience provides valuable insight into the alteration and use of the items in this book. His anecdotes can also serve as the inspiration for *Star Wars* adventures.

This book is an aid for players as well as gamemasters. It is written for the Rebel out in the field without much equipment at his disposal. Players should be allowed to read through the book.

Jury-Rigging

As described on page 29 of *The Star Wars Rules Companion*, a character may increase the performance ability of his equipment. He can make his blaster more powerful or make his airspeeder more maneuverable. Improving equipment through skill points reflects the fact that the character is investing *himself* into the equipment. It is a long-term and costly process.

It is possible, however, to increase the performance of equipment without spending skill points and credits. Unfortunately, this short cut tends to make the improvement temporary, and dangerous when the equipment fails. The process is called *jury-rigging*.

When a character jury-rigs a blaster power pack into a bomb or alters the design of an air speeder's mechanical air flaps, he is making the machine or item better - but by means that no honest engineer would ever use. Jury-rigging

involves connecting wires that shouldn't be connected, taking out important safety features of a vehicle, or putting together two kinds of electronics that don't really belong together. Jury-rigged equipment provides a short term benefit, but it is predisposed to breakdown.

Jury-rigging something takes one hour, or the character can rush, jury-rigging the item in one minute, although the task becomes one difficulty harder. Very difficult tasks can be attempted in one minute. There is no way to spend more time on jury-rigging to make the task easier.

If the roll to jury-rig something is failed, it can be tried again, but the second try always takes an hour (even if the initial attempt was only one minute).

The Role of Jury-Rigging

Jury-rigging equipment often requires strange bits of wire and odds and ends. The gamemaster must decide if the equipment to jury-rig something is on hand if the Rebels did not specify that they brought the equipment with them. The game master should keep in mind that it is in the spirit of the jury-rigging rules that the Rebels slap stuff together when they want to. This is why the break down rules exist: to balance out the bonus the players get. A lack of materials for juryrigging should be the exception, not the rule.

Improving Existing Abilities

The most common way to jury-rig an item is to improve one of its existing die codes. For example, a blaster can be rigged for better damage or an airspeeder can be rigged for more speed. This kind of improvement only enhances a tool's die code (for example, a blaster can only improve the damage code this way, while a capital ship turbolaser could have fire control or damage increased).

An item can be made better by 1D, 2D, or 3D. Thus, a sporting blaster's damage can be improved from 3D+1 to 4D+1, 5D+1, or 6D+1. The maneuverability of an Aratech 74-Z Military

Jury-Rigging Difficulties

| Improving Die Code | Difficulty |
|--------------------|----------------|
| 1D | Moderate |
| 2D | Difficult |
| 3D | Very Difficult |

Speeder Bike can be improved from 3D+2 to 4D+2, 5D+2, or 6D+2.

Jury-rigging requires a successful *technology* roll. The difficulty is determined by the degree of improvement.

Adding New Abilities

Specialized devices can be made from spare parts or an existing item can be modified to have an ability it never had before (for example, juryrigging a blaster so that the user gets bonus dice to hit a target). Changes of this nature are described on a case-by-case basis in this book, with the difficulty listed in the description.

Equipment Failure

Jury-rigged equipment has a chance of failure. The more a piece of equipment is pushed past its original design specifications, the greater the chance of failure. When someone is using a jury-rigged piece of equipment, he should roll the extra dice gained from the jury-rigging *after* the dice he would normally roll (alternately, use different colored dice for the normal roll and the jury-rigged dice).

For example, a blaster with a base damage of 4D and a jury-rigged additional damage of 1D would roll the four dice and then the bonus one die separately.

If any of the bonus dice come up as a one (1), the jury-rigged device has been pushed beyond its limitations and may break down. Roll on the Jury-Rig Breakdown Table.

The bonus dice must always be rolled when the jury-rigged device is used. Therefore, there is always a risk of failure. Bonus dice are never lost as a result of multiple actions in the same round.

Jury-Rig Breakdown Table

Jury-rigged items are divided into four broad categories because different types of equipment break down differently. The categories are: Lethal, Non-Lethal, Vehicles, and No-Dice.

When a player rolls a one on a jury-rig bonus die, the game master makes a secret roll on 1D. He then checks the proper table below to determine the result.

Lethal

- 1 The item explodes, doing damage equal to the amount of the jury-rig bonus.
- 2 The item is broken and cannot be repaired.
- 3 The item stops working, but need only be slammed hard against something to work again. It takes an action to do this.
- 4, 5, 6 The item is fine.

Non-Lethal

- 1 The item is broken and cannot be repaired.
- 2 The item stops working, but need only be slammed hard against something to work again. It takes an action to do this.
- 3, 4, 5, 6 The item is fine.

Vehicles

- 1 All power systems shut down and the vehicle drops like a stone. A Moderate skill roll for the craft is necessary for a safe emergency landing, otherwise the vehicle crashes.

- 2 The vehicle bucks. An Easy skill roll is necessary to keep the vehicle from careening out of control.
- 3, 4, 5, 6 The vehicle is fine.

No-Dice

No-Dice devices do not get bonus dice. All No-Dice devices have a base difficulty to build (noted in the description). The level of success on the building roll determines when another skill roll has to be made to keep the machine functioning. The device will function properly until the next check is necessary. To increase suspense, don't tell the player how long the device will work when he makes his roll. Instead, when the next check is due, just tell him to make another roll.

- If the roll is below the difficulty level, roll on the "Non-Lethal" table. If the item continues to work, roll another No-Dice check in one minute.
- If the roll's success equals the building difficulty level, roll again in 15 minutes.
- If the roll's success is one level higher than the difficulty, roll in one hour.
- If the roll's success is two levels higher, roll again in six hours.

When a roll fails, the jury-rigged device falls apart, complete with sparks and sound effects provided by the gamemaster.

Prosthetics

Prosthetics are one of the many wonders of the *Star Wars* universe. Prosthetics can replace badly damaged tissue, limbs, or internal organs.

Other prosthetics actually enhance a person's abilities, either by allowing him to link directly to a computer (such as Lobot does) or making him stronger or faster.

However, while these prosthetics are available, they are not very widely accepted. The average galactic citizen feels that the distinction between being and machine must remain definite. As machine intelligence advances, the feelings of mistrust and fear grow stronger and stronger. The memories of assassin Droids are too clear.

This judgment extends to the use of prosthetics. People with prosthetic *replacements* are considered a little less than human (or whatever their race), and are often viewed with pity or mistrust. Prosthetic recipients reportedly are less in tune with their natural motivations, attitudes and emotions.

For these reasons, prosthetic recipients often go to great lengths to hide artificial limbs and other alterations (Luke Skywalker's artificial hand is a secret to all but his closest friends).

The use of prosthetic *enhancements* is an abomination to most people. It is widely believed that no amount of improvement is worth giving up part of oneself and one's being. Tools are available to make you a better shot or give you a better computer programming skill - why permanently mutilate yourself?

Enhanced beings often face persecution and curtailment of common civil rights if the enhancement is known. Incidents of mental imbalance among prosthetic recipients are well known. Those with enhancements will often try to hide the fact to make their comings and goings less conspicuous.

These cybernetic enhancements are not meant to be a shopping list for characters. Criminals and others who don't care what society thinks will be outfitted with this machinery, but the players' characters shouldn't be.

Installing Prosthetics

Because of the dangers involved, prosthetics replacements are closely regulated on most worlds, with a long counseling and observation period mandated for recipients. Prosthetic enhancements have been banned or are restricted to those who can afford very expensive permits. Darth Vader is a well known example of both the corrupting influence of enhancements and the ability of the powerful to receive special privileges.

Often, individuals seeking enhancements must go to renegade doctors and risk receiving inferior equipment. Others, such as Lobot, are able

to secure financing from a large corporation or other wealthy entity. The sponsor assures quality enhancements and psychological counseling, while the recipient must agree to an extended period of servitude. After the period of service is completed, the individual is free, but still faces discrimination throughout the galaxy. The Empire has also covertly equipped some of its agents with cybernetic enhancements, although the number of agents is unknown.

Replacements

The primary use of prosthetics in the *Star Wars* universe is to replace limbs and organs damaged beyond repair. Replacements duplicate the abilities of the natural organ or limb. They do not enhance performance in any way. Replacements are fully explained on Datapage 29, "Replacement Prosthetics." The cost listed is the flat fee for the replacement. The cost is not figured by the pip, as enhancements are, because replacements do not increase attributes and skills.

Enhancements

'He's more machine, now, than man -twisted, and evil. "

- Obi-Wan Kenobi,
speaking about Darth Vader

Cybernetic enhancements are available to the desperate of the galaxy. They represent technology at its twisted worst. The technology improves a person's abilities, but reduces their humanity. A cybernetic enhancement makes the recipient less empathic toward other beings and increases his chance to be consumed by the Dark Side of the Force.

An enhancement can be an attachment (such as Lobot's cyborg construct) or a package, which increases an attribute and the related skills. The following section explains the costs for enhancement packages.

Enhancement Costs

When a person buys an enhancement package, he increases one attribute by a number of pips or die codes. Every skill under the attribute increases by the same number of pips or die codes.

Every package has a base cost. Use the following formula for the attribute and every skill under the attribute:

Base cost x pip increase x starting die code of attribute or skill (ignore pips)

Each individual skill must be paid for in addition to the attribute. For purposes of determining costs, each full die code of increase equals three pips. The operation must include all skills and the attribute - a character cannot avoid paying the full price of the operation.

Temptation of Evil

The use of prosthetics is especially dangerous to those who believe in and use the Force. The unnatural combination of man and machine makes tapping the Force harder, but also opens the person to the temptations of the Dark Side once the Force has been called upon. Each prosthetic has a set number of *cyber points*.

When a character calls upon the Force, he must roll a die. If the number is higher than the character's total cyber points, the Force may be used as described in the game. If the roll is equal to or lower than the point total, the character cannot use the Force.

Characters with any cyber points receive double the normal amount of Dark Side points.

Trauma

Characters with prosthetics also risk severe mental trauma as a result of becoming part machine. The effects of trauma should be determined on an individual basis by the gamemaster.

Computer Languages

In our world, a piece of information is either in a computer file or it isn't. The computer technology of the *Star Wars* universe is very different, thanks to the development of Artificial Intelligence (AI) brains for Droids. By working with Droids, programmers and computer linguists created what they called Holistic Data Transfers, or HDTs.

HDTs are a means of writing data files in a kind of "information shorthand." HDT languages are so sophisticated they take up very little memory, but they allow a datafile to give a computer user more data about a topic than it actually has.

HDTs build an element of artificial intelligence directly into datafiles. In effect, it makes a "guess" about the information requested based on the data it possesses. The more data it possesses, the more accurate the deductions and the broader the scope of the deductions.

The larger the file, the less chance the computer will have to guess. Large files can be broken down into smaller files if necessary.

The Death Star technical readout of IOD (such as the one carried by R2-D2 in *A New Hope*) will have just about any information the user is looking for. The file could be broken down into two 4D files and a 2D file. Each one of these smaller files would have less chance of providing the necessary information.

Data in the Game

All files are rated in terms of die codes. For simplicity there are no pip values - just straight die codes: 1D, 2D, 3D, 4D, and so on up to 13D. Most

Example of Enhancement Cost

A character is improving his *Perception* and related skills two pips with a Sensory Package. The package's base cost is 300 credits. On the first line, see that the cost is 3 (starting die code) times 2 (pip increase) times 300 (base cost)

| Skill/ Attribute | Starting Die Code | Formula | Cost | New Die Code |
|---------------------|----------------------|-------------|----------------|-----------------|
| Perception | 3D | 3 x 2 x 300 | 1,800 | 3D+2 |
| Bargain | 3D | 3 x 2 x 300 | 1,800 | 3D+2 |
| Command | 3D+1 | 3 x 2 x 300 | 1,800 | 4D |
| Con | 4D+2 | 4 x 2 x 300 | 2,400 | 5D+1 |
| Gambling | 3D+2 | 3 x 2 x 300 | 1,800 | 4D+1 |
| Hide/Sneak | 3D | 3 x 2 x 300 | 1,800 | 3D+2 |
| Search | 3D | 3 x 2 x 300 | <u>1,800</u> | 3D+2 |
| Total= | | | 13,200 credits | |

files will have a die code of 4D or less, although a few files have more complete information.

Computer files are *very* specific. Examples of files include the Death Star, X-wing fighters, R2 Astromech Droids and Hoth system. The cost for such files varies depending upon the importance of the information and the power of the program. Files with larger die codes are much more expensive than smaller files. It will be nearly impossible for Rebels to buy a file greater than 4D without resorting to underground contacts and other illicit means.

Typical file costs:

- 1D 100 Credits
- 2D 400 Credits
- 3D 600 Credits
- 4D 1,000 Credits
- 5D 4,000 Credits
- 6D 6,000 Credits
- 7D 10,000 Credits
- 8D 40,000 Credits
- 9D 60,000 Credits
- 10D 100,000 Credits
- 11D 400,000 Credits
- 12D 600,000 Credits
- 13D 1,000,000 Credits

Currents limits of technology do not allow files greater than 13D.

In addition to cost, the Rebels must go to someplace where they can get the file. A quest could be built around retrieving several different datafiles.

Data Storage

Computers have a limitation on the amount of information they can store. Common pocket computers can store 5D at most (although many store less), while portables can store up to 20D.

Computers on capital starships can store up to 30D, while planetary computer systems store up to 100D of information.

Reading the File

The player may make a standard *computer programming* roll or have the datafile do the search for him. To have the datafile search for information, the character needs to make a Very Easy *computer programming* roll. If he succeeds, the computer calls up the datafile. The gamemaster then sets the difficulty number for getting the requested information, and the player rolls the datafile's die code to see if the information is available. If the roll succeeds, the gamemaster gives the information to the player. The Rebel may not spend a Force Point to increase the value of the roll.

Portables

Most decent computer programmers will be better at manipulating a datafile than the file is at manipulating itself. With pocket computers (or datapads) and most other computers, the memory die code may be substituted for the character's die code.

However, expensive portable computers actually enhance the programmer's skill by adding additional dice to the character's *computer programming* roll.

Combining Files

Characters can combine files on the same topic. Because of the strange computer language of the *Star Wars* universe, breaking files down into small chunks is easy, but reassembling them is hard. To reassemble two files, a *computer programming* roll is required. The difficulty is set by the *total* die codes of the files that the Rebel is trying to combine. Both files must be within one die code of each other, and the new file is increased by only one die.

| Total | Difficulty |
|------------|----------------|
| 2D | Easy |
| 3D | Moderate |
| 4D | Difficult |
| 5D or more | Very Difficult |

If the roll is failed, each file loses a die code of information.

For example, a character has a 3D file on Bespin and another 2D file on Bespin. The die code total is 5D, so the character must make a Very Difficult *computer programming* roll to combine the files. If he succeeds, the new Bespin file will be 4D. If he fails, each file will lose a die code, so he will have one 2D file and one 1D file on Bespin.

■ DATA.SEARCH ■ PROG40046 ■ FILEPATH 9011/29P//EQP.ADB//SC ■ FILEFORM..D.PAD/DOWNLOAD
■ SOURCEFILE: CRACKEN'S REBEL FIELD GUIDE

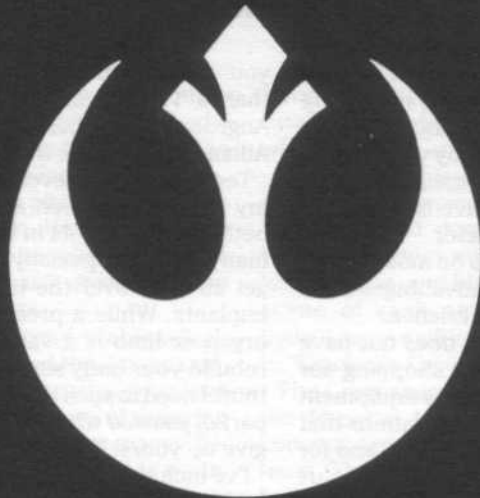

Cracken's Rebel Field Guide

■ C O N T E N T S ■

| | |
|--|-------------|
| Section One: General Airen Cracken | Datapage 8 |
| Section Two: Computers | Datapage 10 |
| Section Three: Equipment | Datapage 13 |
| Section Four: Jury-Rigging | Datapage 22 |
| Section Five: Prosthetics | Datapage 29 |
| Section Six: Vehicles | Datapage 42 |
| Section Seven: Weapons | Datapage 63 |

← PREVIOUS

DATAPAGE: 7

NEXT →

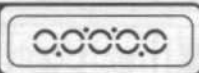

FELLOW REBELS IN THE FIELD:

I've been told that a lot of you are familiar with my exploits and that you consider me something of a legend. I don't see why you should. Every one of you are heroes, and some day your stories will be legendary as well. Your membership in the Alliance shows that you have tremendous bravery, conviction, and character.

However, I do have a few years on most of you. Rebel HQ thought it would be advantageous if I passed on some of my field experience.

The Rebel Alliance, of course, does not have the resources and funds to go shopping for supplies. Sometimes it receives new equipment or donations from systems or corporations that have thrown their loyalty to the cause, and for that the Alliance is grateful, but for the most part troops make do with what is at hand.

This datafile was written with this understanding. What few supplies the Alliance has must be carefully doled out to major operations. This datafile is for those of you who pave the way for the major offensives by getting behind Imperial blockades, making diplomatic contacts with beleaguered star systems, running covert operations to obtain documents, and other important missions.

In short, this datafile is for the Rebel on the go who doesn't have much backing him up.

The information herein depends on a familiarity with technology. We live in an age of technological marvels — and dangers. You must all become familiar with the way things work. It is not enough that machines do tasks for you, for with that attitude you are imprisoned by the abilities of the machinery. You must be able to make the machine do what you need it to do. If

you can't handle technology, you're no better than a Throg-bellied, soft-spined, blue-haired Angroosh who doesn't stand a chance in the Alliance the minute things get rough.

Technology, however, can be seductive. Over my lifetime I've seen a proliferation of cybernetic enhancements in black market trade. Too many people, especially the youngsters, want to get an edge over the universe with electronic implants. While a prosthetic to replace a lost organ or limb is a valid choice, the desire to rebuild your body simply to be better. . . I don't think I need to spell this out, but you're giving up part of *yourself* when you do that. And you can't give up yourself without paying a steep price.

I've included some of the cybernetic packages in this volume so that you're aware of what's out there — not so you'll run out and buy one. You should know that there still exists a great prejudice in the galaxy against cyborgs. To be part machine is to earn the distrust of almost everyone you run into. From what I've seen of what happens to people who start to rely on these machines, the mistrust is well founded.

I also want you all to think about the importance of information. The new kids coming up think this war is all about zipping around in under-armored starfighters. The real battle is fought with information! How do they think the Alliance won the battle of Yavin? Skywalker wouldn't have been able to do Bantha poot with his X-wing if he hadn't gotten those plans to the Rebellion!

Anyway, these are the random recollections of a man who spent a great deal of time making it up as he went along. I pray that you find the same success that I did.

May the Force be with You,
General Airen Cracken

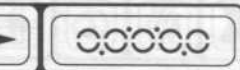

■ DATA SEARCH ■ PROG40046 ■ FILEPATH 9011/29P//EQP.ADB//SC ■ FILEFORM..D.PAD/DOWNLOAD
■ SOURCEFILE: CRACKEN'S REBEL FIELD GUIDE ■ SECTION TWO: COMPUTERS ■ DESIGNATION..

MICROTHRUST PORTABLE COMPUTERS

Portable computers, or portables, are a significant advancement over pocket computers. They allow the user to prepare and write programs to use against other computers. Although Droids can often serve the function of portables, they're often not available for the task. A portable can fit into a backpack.

There are many portables on the market; one of the most popular is the MicroThrust line. These machines are specifically designed for computer intrusions and are equipped with a vast array of interface ports so the user doesn't have to carry around a dozen cable adaptors.

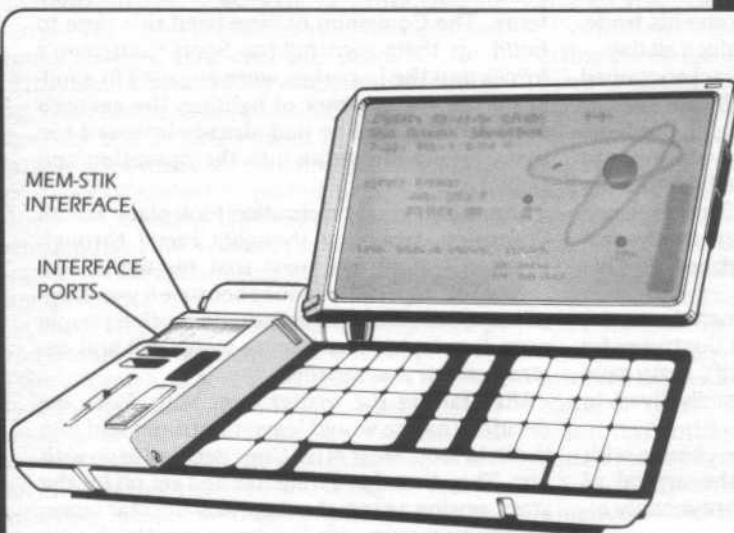

■ Specifications

Items: MicroThrust Portable Computers
Availability: F

Every portable has a power and memory rating.

■ Power

The power ratings range from 0D to 5D. A Rebel using a portable adds the machine's power to his *computer programming* roll. Power cannot be upgraded — a new computer has to be bought for more power.

| | |
|----------|----------------|
| 0D Power | 5,000 Credits |
| 1D Power | 10,000 Credits |
| 2D Power | 25,000 Credits |
| 3D Power | 35,000 Credits |
| 4D Power | 45,000 Credits |
| 5D Power | 55,000 Credits |

■ Memory

A portable comes equipped with 5D of memory. Each additional 1D costs 500 Credits. Memory can be upgraded by paying the cost of the additional memory. Maximum memory is 20D.

To calculate the price of a portable add the cost of the power to the cost of the memory.

■ ADDENDUM/PERSONAL ■ CRACKEN, AIREN/GENERAL..

Many people are stunned when they realize how expensive portables are. That's because most people haven't used them and don't realize how powerful they are.

In our society most people use machines without thinking about how they work. That's how machines are designed — so you don't have to think about them. Portables are designed specifically to think about machinery. Even pocket computers, which let you access data from a mainframe, only let you have what the designer of the mainframe wants you to have. The mainframe gives instructions to the pocket computer.

On the other hand, the portable can take control of a mainframe. With a portable you are in charge of what's going on.

Most people don't use portables because they have Droids. I suggest a portable because Droids are terrific . . . until they get temperamental. And you can't work with a Droid on the computer system you're slicing as effectively as you can with a portable.

But that's just my opinion. Others disagree with me and see portables as an archaic money drain.

← PREVIOUS

DATAPAGE: 10

NEXT →



SMUGGLING DATA IN A BLASTER

To store computer data in the handle of your blaster, you'll need a HiBaka 2000 mem-stik, and Rergo IV power condenser. You'll also have to hollow out the handle to make room for the mem-stik.

First, plug the mem-stik into the computer you're taking the data from. Then download the data you need into the mem-stik (most systems will default to the mem-stik if you give a memory tag of 8730837). The mem-stik will hold 14 Bz of data. That isn't much data, but you can break the information down into several mem-stiks. A blaster can hold a single mem-stik.

You can't just take the stiks out of the computer or you'll lose all the data. Open your blaster handle and disconnect the power flux dispersion unit. Attach the condenser to the apas connectors, then attach the ends of the condenser to the stik prongs, and unplug the stik from the computer. Then put the stik in the handle of the blaster and close it up.

Specifications

Function: Smuggling Data in a Blaster

Components:

Blaster With Hollowed Out Handle
Hi-Baka 2000 Mem-Stik
Rergo IV Power Condenser (from any computer tool kit)

Availability:

Hi-Baka 2000 Mem-Stik: 2

Cost: 50 Credits

Each mem-stik contains 1D of data. The information can be broken down and reassembled into a larger file later on.

The data is lost if the blaster is fired. If fired, the user suffers 3D damage from heat and burns.

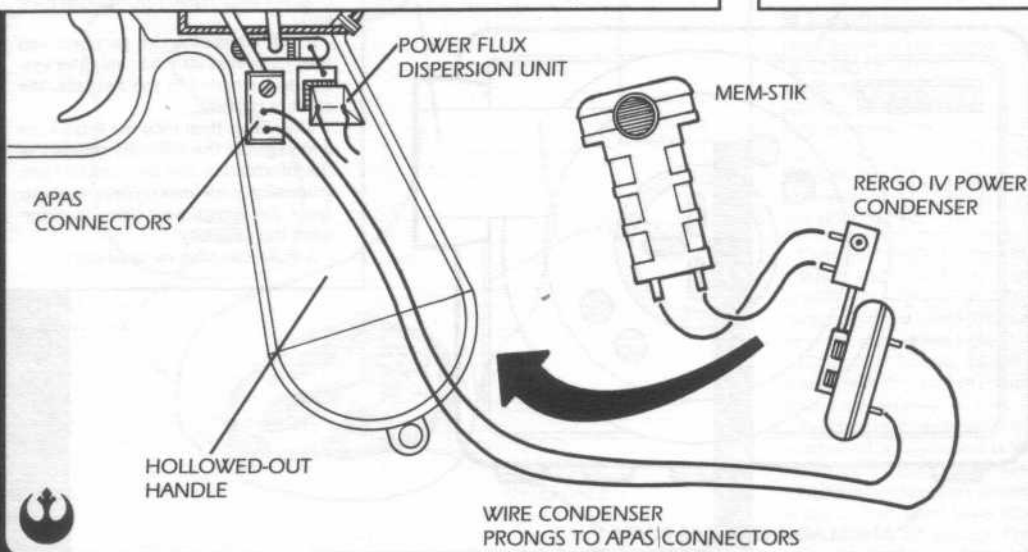

ADDENDUM/PERSONAL ■ CRACKEN, AIREN/GENERAL..

Because cyborg and vessel hardware is expensive, there is no point in counting on such constructs being available for the transfer of sensitive data. What is a Rebel to do when he has something he needs to move secretly?

My answer was to put the information in the handles of my group's blasters. I've been searched plenty of times for optical disks, but no one ever stopped to look inside my gun to see if there was an active mem-stik humming away inside.

The only danger with this plan is that you can't fire the blaster with the mem-stik in it. The apas connectors normally attach to the gun's power flux dispersion unit, which dissipates excess flashback energy. Since the power flux dispersion unit is disconnected for this little trick, if the blaster is fired the power overload burns out the mem-stik and blows out the blaster. Not only do you lose the data, but it hurts.



IMPERIAL BIO-HOUND

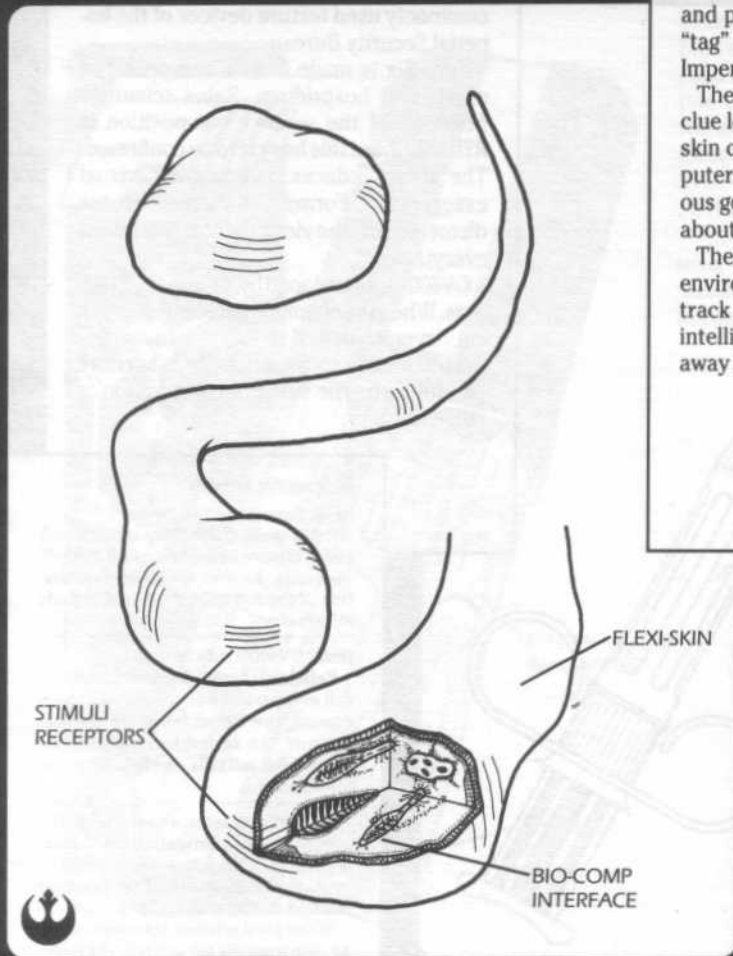

The Imperial bio-hound is part computer and part living organism. It can track and "tag" targets more efficiently than most Imperial agents.

The bio-hound must be given a genetic clue left by the target — a strand of hair, a skin cell, or an article of clothing. Its computer is designed to cross-reference various genetic clues, allowing it to learn more about the target as the search goes on.

The device can be let loose in almost any environment — desert, city, forest — to track down its prey. Because it is semi-intelligent it can manage tasks like stowing away aboard a ship to pursue its prey.

Specifications

Item: Imperial Bio-Hound

DEXTERITY: 2D

KNOWLEDGE: 3D

MECHANICAL: 1D

PERCEPTION: 5D

Search: 6D

STRENGTH: 2D

Brawling: 3D+1

TECHNICAL: 1D

Uses *search* skill to track target.

When target is found, continually broadcasts warning signal to receiver (range of 50,000 kilometers). Agents at receiver will pursue signal.

Bio-hound follows target and secretes Heldrium-Bastelt chemical compound on target.

Receiver unit can be attuned to track compound if bio-hound is separated from target (range of one kilometer).

Some bio-hounds are armed with an acidic poison. Must make *brawling* attack to inject. 5D damage. Five doses.

Can drastically alter shape. Is a mottled grey in color. Often appears similar to a large worm or snake, although it can roll into a ball or other form.

ADDENDUM/PERSONAL ■ CRACKEN, AIREN/GENERAL..

This device is best used when the Empire knows a wanted Rebel agent has been at a facility but is long gone. The bio-hound is introduced to anything with the target's genetic code and is turned loose. It could tuck itself into your backpack, drop down on you from scaffolding, or be waiting for you when you unpack your cot. Its intelligence allows it to solve the problems of tracking its target and little else.

Biogears Unlimited, a new bioengineering company bankrolled by the Empire, recently sent the first three hundred models of the bio-hounds out for field testing. Targets currently range from Alliance diplomats to Rebel field soldiers. Since some Rebel operatives aren't

worth sending an agent to hunt them down, many of the bio-hounds have been equipped with a deadly poison. This is a quick and cheap assassination tool for the Empire and it works with frightening efficiency.

If you are tagged with the tracer compound (a clear, odorless liquid), you will have to remove the article of clothing and hope to avoid the bio-hound and its agents long enough to leave the planet.

If you manage to get off a planet before it follows you onto a ship, you've probably lost it, since it can't find out which system you've travelled to. On the other hand, if it picks up your scent from the west, it is clever enough to slip onto a vehicle going west and travel toward you.



BAVO SIX AND OV600 TRUTH SERUMS

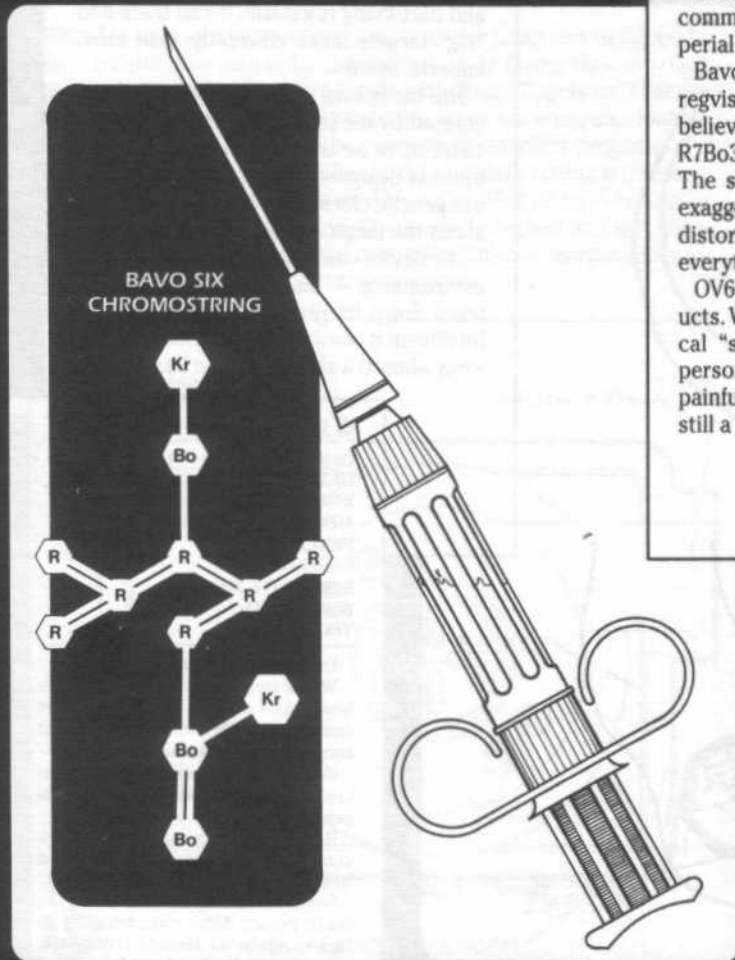

These two truth serums are the most commonly used torture devices of the Imperial Security Bureau.

Bavo Six is made from a compound of regvis and bospridium. Rebel scientists believe that the serum's composition is R7Bo3Kr2, but this has yet to be confirmed. The serum induces paranoia and visual exaggeration. Forms and shapes become distorted, and the victim becomes afraid of everything.

OV600 was developed by 'Geneering Products. When the chemical detects the physical "symptoms" of a lie, it causes the person's flesh to break out in a horribly painful rash. The serum's composition is still a mystery.

■ Specifications

Item: Bavo Six Truth Serum

Rebel must make *Easy stamina* roll every minute of game time. If the roll succeeds, he can withhold information. If the roll fails, the Rebel reveals information.

Item: OV600 Truth Serum

Rebel must make *Moderate stamina* roll every minute of game time. If successful, the Rebel takes 2D damage because the serum tortures him for lying. If the roll fails, the Rebel reveals information.

The gamemaster should give the player a list of information his character knows. This information might or might not be information that the *player* learned during game play.

When a roll is failed, the player picks an item from the list and tells the Imperials about it.

One dose of either serum is effective for five minutes.

■ ADDENDUM/PERSONAL ■ CRACKEN, AIREN/GENERAL..

The Imperial Security Bureau has developed many types of truth serums over the years. Bavo Six is a nasty one, and easy enough for Imperial chemists to produce. I had it used on me when I was captured on Quanton.

I desperately tried not to tell them anything. When the room began to spin and the stormtroopers around me began to shift into demonic creatures, I thought of the comforting warmth of my home world's sun. The ISB officer's laugh sounded like a Star Destroyer had suddenly been empowered with speech, metallic and booming. I opened my eyes and saw that everyone had become a monster waiting to devour me. It was real to me.

I broke several times. There is no shame in breaking down. Accept it.

I could never remember what I said. I will never know if certain defeats that were to come much later came about because of what I told them.

As for OV600, it works on the physical level. As the person lies, he brings pain to himself and perhaps death.

One time, one of my men was captured in Mos Eisley. We knew that they were going to torture him with OV600. It was a tense race as we dashed through the streets of the city looking for the Imperial torture chamber.

Eventually we found him, but it was too late. He had died telling lies to protect the Rebellion.



BIOTECH FASTFLESH MEDPAC

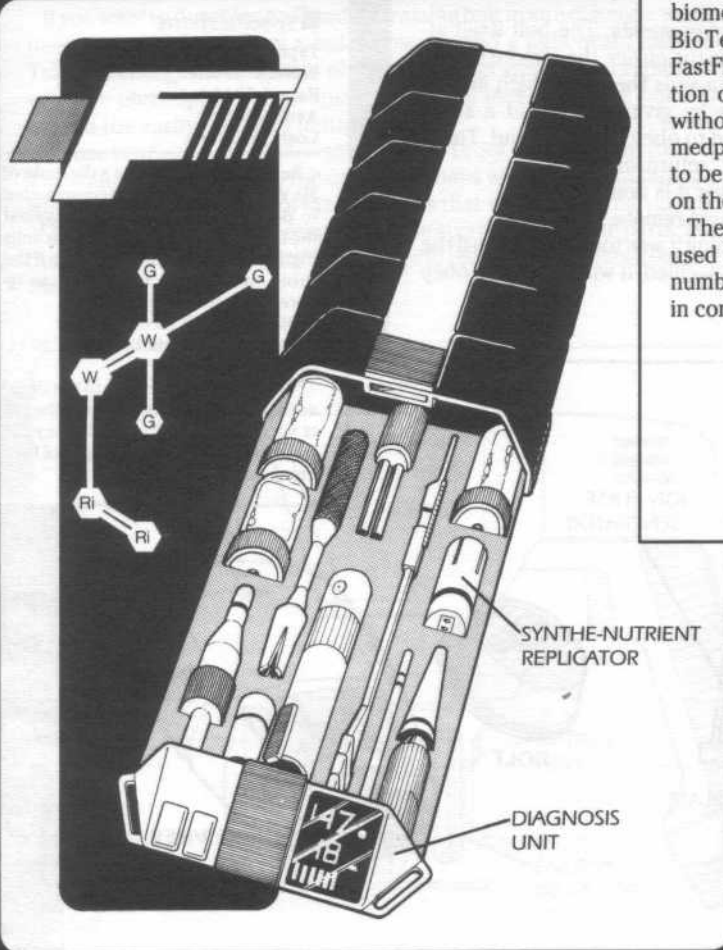

Utilizing a variety of newly developed biomedical synthetic chemicals, including BioTech's patented chromostring, the FastFlesh medpac delivers deeper penetration of healing agents to a wound victim without damage to nerves. The FastFlesh medpacs are easier to use and guaranteed to be more effective than other medpacs on the market.

They are so powerful they can only be used once a day. However, an unlimited number of standard medpacs may be used in combination with FastFlesh medpacs.

Specifications

Item: BioTech FastFlesh Medpac
Type: Advanced Medpac
Skill Code: Medicine
Availability: 2
Cost: 500 Credits

Use the following difficulties for FastFlesh medpacs:

| | |
|------------------|----|
| Wounded | 5 |
| Incapacitated | 10 |
| Mortally Wounded | 15 |

FastFlesh medpacs cannot be used more than once a day. Normal medpacs can be used several times in combination with the FastFlesh.

ADDENDUM/PERSONAL ■ CRACKEN, AIREN/GENERAL..

The Force is with us! Thank goodness a quicker, more dependable medpac is available. I don't know how many close calls I had out in the field due to limited medical supplies. Now we can do daring deeds without fear of certain death!



DROID RESTRAINING BOLTS

The Droid restraining bolt has two components. The bolt itself attaches to the Droid. The second device is the *owner*, the remote device that activates the bolt. The owner commands the bolt, which in turn commands the Droid. The bolt works by giving the Droid a small microburst of ionization to get the Droid to obey the command. There are three commands on the owner: halt, return, and orders.

"Halt" forces the Droid to stop whatever it is doing.

"Return" calls the Droid to the hand-held remote.

"Orders" forces the Droid do the last thing it was told to do. Even if the Droid can't complete the command as specified, it will attempt to obey the order.

■ Specifications

Type: Droid Restraining Bolt

Scale: Character

Range: 50 Meters

Availability: 1

Cost: 75 Credits

Restraining bolts have a die code of 3D. Whenever the Droid is commanded to do something, roll the 3D against the Droid's *Perception*. If the bolt rolls higher, the Droid obeys the bolt. If the Droid rolls higher, the Droid can ignore the restraining bolt.

"Halt" lasts 10 seconds.

"Return" compels the Droid to return.

"Orders" gives pleasure to the Droid so that it will obey its master. If the roll is successful, the Droid will obey the owner regardless of the length of time involved.

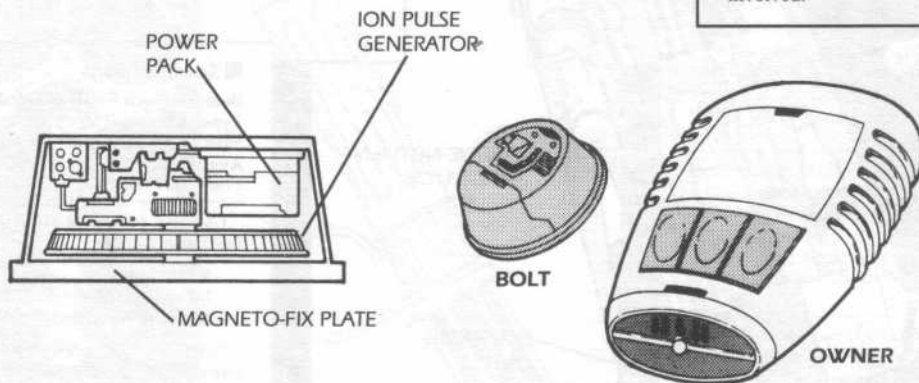

■ ADDENDUM/PERSONAL ■ CRACKEN, AIREN/GENERAL..

Restraining bolts were created when it was discovered that Droids were developing personalities as a result of their sophisticated electronic brains. Rather than reduce the capability of the brains it was decided to develop an electronic "harness" for the Droids. Restraining bolts fit this capacity nicely, allowing the Droid to use its full abilities while keeping it mostly subservient to the Droid's master.

New Droid owners often don't know what to expect from their property. Droids have been known to lie and be evasive. If the owner has reason to believe that the Droid is less than completely loyal, the bolt is preferential to a mind wipe.

The owner is a remote device with a unique frequency and identification code. This way one owner won't call five bolt-controlled Droids on a busy city street. The bolt is attached to the Droid with a magno-fix. Each of the three options gives the Droid a small ion jolt and forces it to obey the owner.

Restraining bolts are used when the Droid's master is unsure of its loyalty. The bolt insures that the Droid won't run away or otherwise follow its own whims. If the Droid proves its loyalty over time the bolt is often removed.



DEACTIVATING A DROID RESTRAINING BOLT

If you want to deactivate a Droid restraining bolt from a distance, you'll need a pivar spinner from a holo-projector and a tight-beam emitter. Take the energy cartridge out of the tight-beam emitter and replace it with the pivar spinner. The spinner's optical lens should be pointed toward the casing's energy inductor.

To use the device, point the emitter at the Droid that you want to free. The spinner, fit snugly into the casing (perhaps with a bit of cramming), will emit a steady stream of mag-particles that will cling to the surface of the Droid for about two minutes. While surrounded by the particles, the Droid's restraining bolt will be unable to receive commands from the owner.

■ Specifications

Function: Deactivating A Droid Restraining Bolt

Components:

Pivar Spinner (from a holo-projector)

Tight-Beam Emitter (found in vehicle repair kits)

Scale: Character

Skill Code:

Build: Technology

Use: Blaster

Building Difficulty: As per Jury-Rigging Rules

Range:

Short: 3-7

Medium: 8-25

Long: 31-120

Jury-Rig Type: Non-Lethal

Increases Droid's Perception 1D, 2D, or 3D when determining if the Droid must obey the restraining bolt.
Lasts 24 rounds.

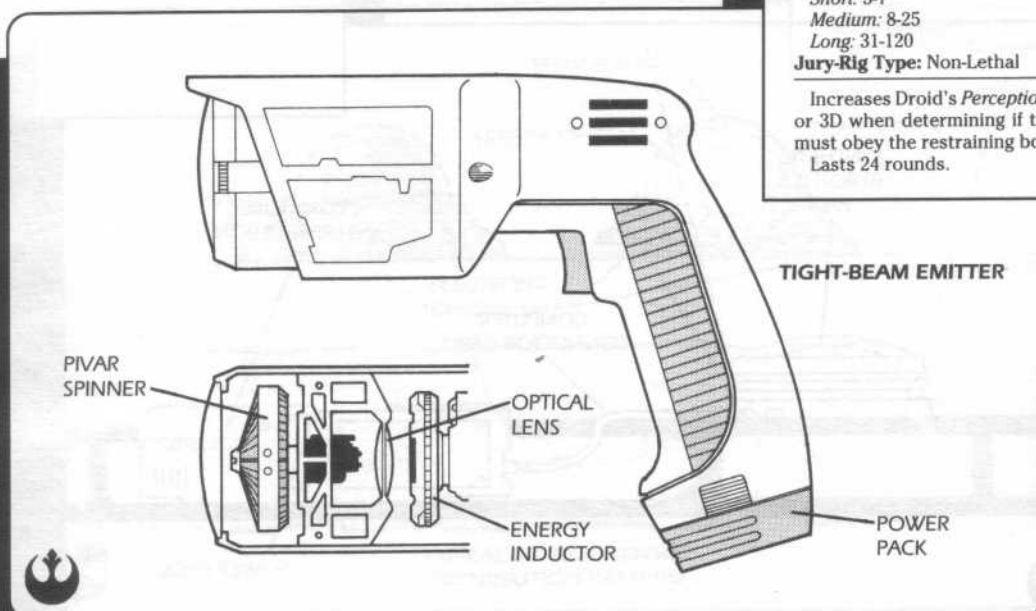

■ ADDENDUM/PERSONAL ■ CRACKEN, AIREN/GENERAL..

I came up with this device when my Droid Vee Gee was stolen by a band of ruffians on the water world of Barison. The pirates had fit him with a restraining bolt. Although they let him wander around freely on their primitive wooden ship, I'd never get him off as long as the restraining bolt was on him. Since the hull of their ship was lined with countless spikes, I was unable to climb up and remove the bolt myself.

To free him, I rigged up this device. During the night, I rowed up to their ship in a small, primitive skiff borrowed from a local sea farmer. Vee Gee stood by the railing of the massive vessel. He instantly saw me and gestured to the restraining bolt fixed to his left shoulder.

I raised my device and fired.

In a flash, he knew he was free. I saw the light of the moons glint off his armor as he quickly went across the deck and grabbed a rope ladder and dropped it over the side. I heard a guard call, "Hey!" then, "Hey, Stop!" and then finally, "Hey! It's not working!" By this time, Vee Gee was over the side of the boat and nearly to the bottom of the ladder.

When the guard rushed to the railing after Vee Gee, I was ready with my blaster and took the pirate out with a single shot. Vee Gee climbed into my craft and took the paddles, ferrying us from the ship while I kept the pirates at bay with my blaster.

← PREVIOUS

DATAPAGE: 17

NEXT →



■ DATA SEARCH ■ PROG40046 ■ FILEPATH 9011/29P//EQP.ADB//SC ■ FILEFORM..D.PAD/DOWNLOAD
■ SOURCEFILE: CRACKEN'S REBEL FIELD GUIDE ■ SECTION THREE: EQUIPMENT ■ DESIGNATION..

IMPERIAL HEAT SENSOR TRIP

The new heat sensor trips used by the Empire are usually set into walls or other structures. The trips consist of two parts. The first is the small lens, which covers a 45-degree arc in front of it. This lens is made from the synthetic byrothsis and it can scan anything in its field of vision for a complete breakdown of heat.

The second component is the computer system, which must be supplied separately. Any datapad will do, as long as this is the only task it is doing. The system triggers an alarm for all heat images unless the computer is programmed to accommodate certain heat patterns. For example, the computer can be instructed to ignore small avians within a certain heat range.

■ Specifications

Item: Imperial Heat Sensor Trip
Range: 20 Meters, 45-Degree Arc
Availability: X

Sensor can be programmed to set off alarms or notify a central computer.

Character must disable heat sensor or successfully disguise his heat pattern as a proper shape and heat pattern to pass by undetected.

Sensor connected to computers by 50-meter long cable, although multiple cables can be connected for greater range.

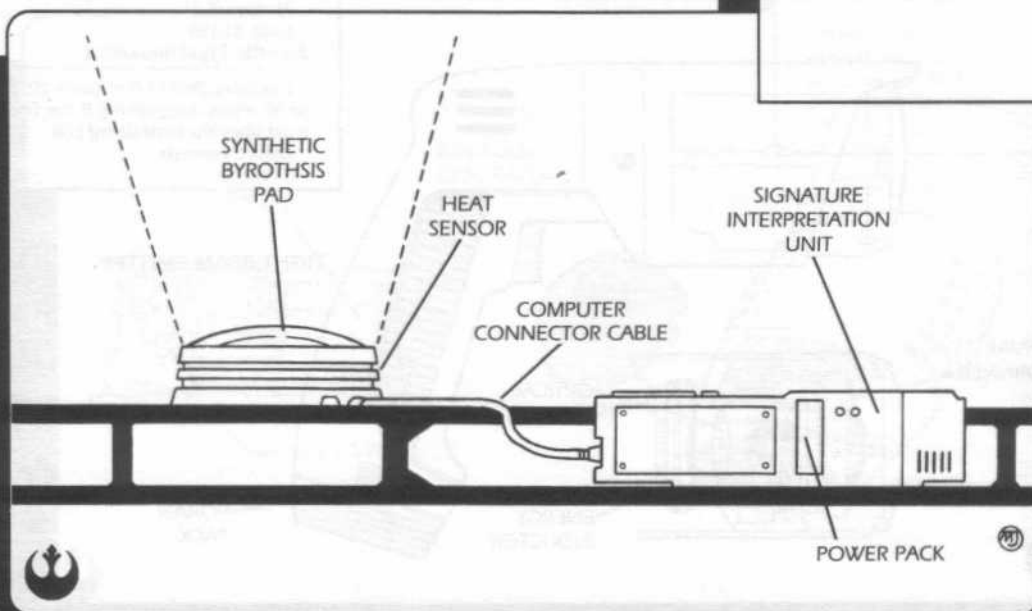

■ ADDENDUM/PERSONAL ■ CRACKEN, AIREN/GENERAL..

Heat sensor trips have only become practical in recent months with the development of ResSystem's synthetic byrothsis. Natural byrothsis, which is used to build IR camera lenses, is very rare and expensive. The synthetic replacement has created an entire industry based on its application. Most of these applications have been on the drawing boards for several years, waiting for a cheap means of production.

This device's advantages over standard motion detectors are clear. The heat sensor lenses are so precise that the trip can be calibrated to ignore certain broad categories of creatures while still allowing accurate detection of specific intruders. They can be used outdoors without

any trouble, and do not have to be turned off when friendly units pass by them.

For example, at the bases where the new systems have been installed, stormtrooper armor has been coded into the computer memory bank because the armor has its own standard heat signature. The trips have been told to ignore any heat signatures that contain the pattern of a stormtrooper uniform. It doesn't matter what the rest of the signature looks like as long as the armor signature is part of it. I've reason to believe that heat producing elements have been added to the stormtrooper armor at these bases. If this is true, stormtrooper armor from outside the base will trigger the trips.

← PREVIOUS

DATAPAGE: 18

NEXT →



BLASTECH MOVESENSE 34 MOTION TRIP

These sensors utilize sophisticated sense-constro technology pioneered by BlasTech's Aoral Sensor 100. However, the technology may be too sophisticated because sensors have been known to be triggered by a brisk breeze or passing avian. The sensor is activated by microchanges in air density within their range.

Each unit has a small dome-shaped sensor about four centimeters across, which constantly shoots out low frequency sonic bursts. The trip finds the average air density motion and calibrates itself to that. When there is a shift from the average air density motion, the sensor notices the new pattern and trips whatever device is on the end of the cable.

■ Specifications

Item: BlasTech MoveSense 34
Motion Trip
Type: Motion Sensor
Range: 4 Meter Diameter
Availability: F
Cost: 100 Credits

Finding sensor requires Difficult security roll.

Sneaking by a motion sensor trip requires a Difficult *hide/sneak* roll.

Alarm emits a piercing shriek when triggered.

Can be remotely turned on and off with calibrated security systems. System must have transmitter within 50 meters of sensor.

Unit is cubed, six cm to a side.

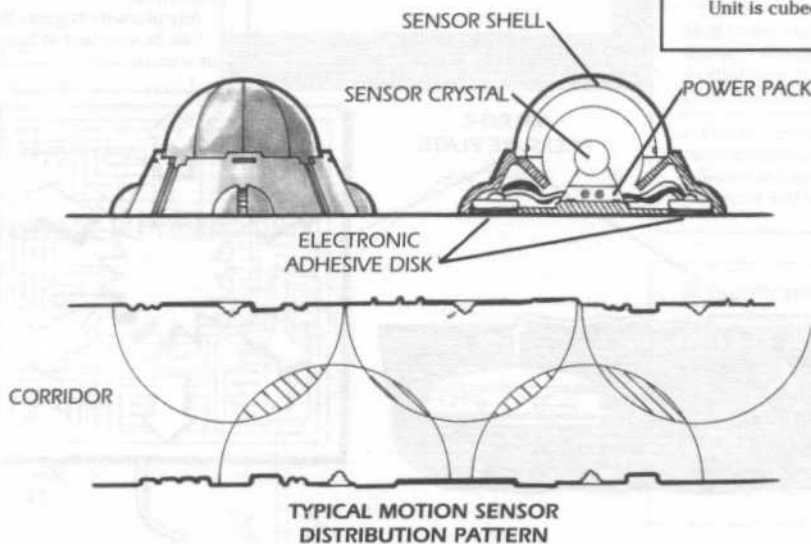

■ ADDENDUM/PERSONAL ■ CRACKEN, AIREN/GENERAL..

Motions sensors work best indoors. Although they can be used outside, it's frequently a lot of work to get them to work correctly. Wind can set off a field of sensors. If you've got an area that is calm, go ahead and use them, but I'd set them first, and then observe for at least an hour to see if you get any false alarms. Wildlife can also set off the alarms.

Because of their dome-shaped sensor patterns, a single sensor may not cover a room or corridor effectively. I suggest an overlapping pattern, as pictured in this file.

The sensors are usually wired to system on/off switches. This way the security control room of an area can turn the systems off in a particular corridor so that friendly parties may pass by the sensors without setting off alarms or traps.



PRESSURE PLATE TRIP

Zone Supplies, Ltd.'s Pressure Plate Trip is standard issue for Imperial troops. It has adaptors that connect it to a variety of jack types, including blasters, alarms, and bombs. The flexible, square plate can be rolled up when not in use and is very easy to transport. The plate is only three centimeters thick, but is triggered by a very slight amount of pressure.

Specifications

Item: Zone Supplies, Ltd. Pressure Plate Trip
Type: Trip Sensor
Availability: F
Cost: 300 Credits

Two sizes: one-third meter by one-third meter, and one meter by one meter.

Small trips weigh 300 grams.

Large trips weigh one kilogram.

Power pack lasts 72 hours.

Characters must make a *search* roll to detect the traps. A Moderate roll is necessary to spot the large trap, while a Difficult roll is necessary to spot the small trap.

Any pressure triggers the plate.

Can be attached to blasters, bombs or alarms.

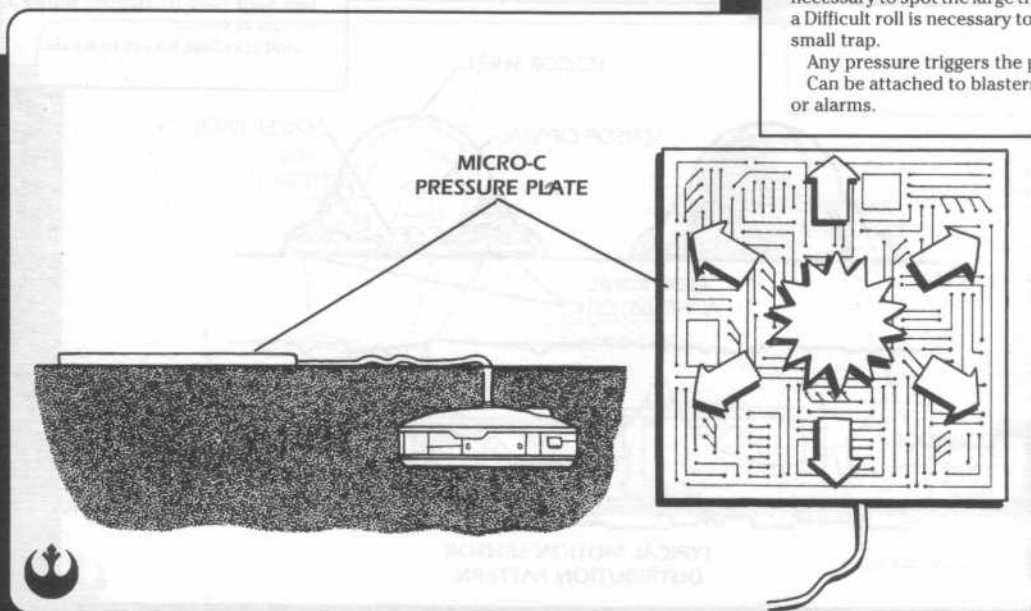

ADDENDUM/PERSONAL ■ CRACKEN, AIREN/GENERAL..

These plate trips come in a variety of colors for different areas: white for arctic conditions, blue for shallow water, green for swamp floors and so on. Imperial forces seldom simply lay their mats out. Stan-

dard procedure is to roll out the plate and cover it with at least a shallow layer of dirt, snow or whatever else is appropriate for disguise.



FALSE VOICE TRANSMITTER

With this jury-rigged machine you can impersonate someone else over a voice-only communication system. To make this device, you'll need the brain of a protocol Droid, and the vox-synth box from the Droid (so the brain can speak).

To create the device, remove social inhibitors K2 through K8 and modular personality systems 82B, 54D, and 66D. Then jack a pocket computer into the brain's left data port. Type instructions to the brain and tell it what to say. If the Droid has heard the voice of the person you're trying to imitate, the trick should be convincing. Otherwise, you'll have to help the Droid reconstruct the voice, which is a laborious process.

Specifications

Item: False Voice Transmitter

Components:

Protocol Droid Brain
Protocol Droid Vox-Synth Box
Pocket Computer

Skill Code:

Build: Technology

Use: Con

Building Difficulty:

Easy if Droid has heard voice before
(normal Jury-Rig time)

Difficult if voice must be recreated
(takes one day)

Jury-Rig Type: No-Dice

Operator must make a *con* roll based on the situation. If the programmer had to reconstruct the voice of the person being impersonated from memory, add one level to the normal difficulty.

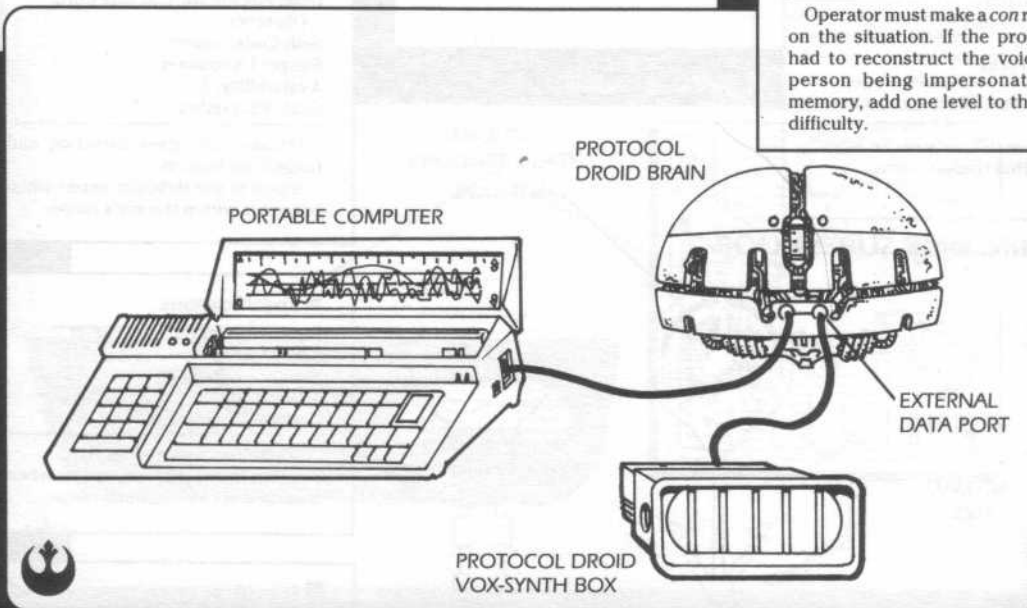

ADDENDUM/PERSONAL ■ CRACKEN, AIREN/GENERAL..

This is one of the ways you can effectively use a disabled Droid. The brain of a protocol Droid is an incredibly valuable piece of equipment and should never be tossed away, no matter how badly damaged the Droid is.

Things are easier if the Droid heard the voice of the person you are trying to mimic and retained the voice in its memory banks. The Droid only needs to have heard a few sentences. From these few scraps of sound, the protocol Droid, programmed to speak in countless lan-

guages and dialects, can construct a solid speech pattern. Specific speech patterns and phrases of the person being mimicked are up to the person at the computer keyboard. All the vox-box can do is speak the words you give it with the correct register of voice and accent.

If the voice is not in the Droid's memory, then the keyboard operator will have the Droid try out one voice after another, making slight alterations until the desired voice has been constructed. This process can take about a day.

HOLO-BIT GENERATOR

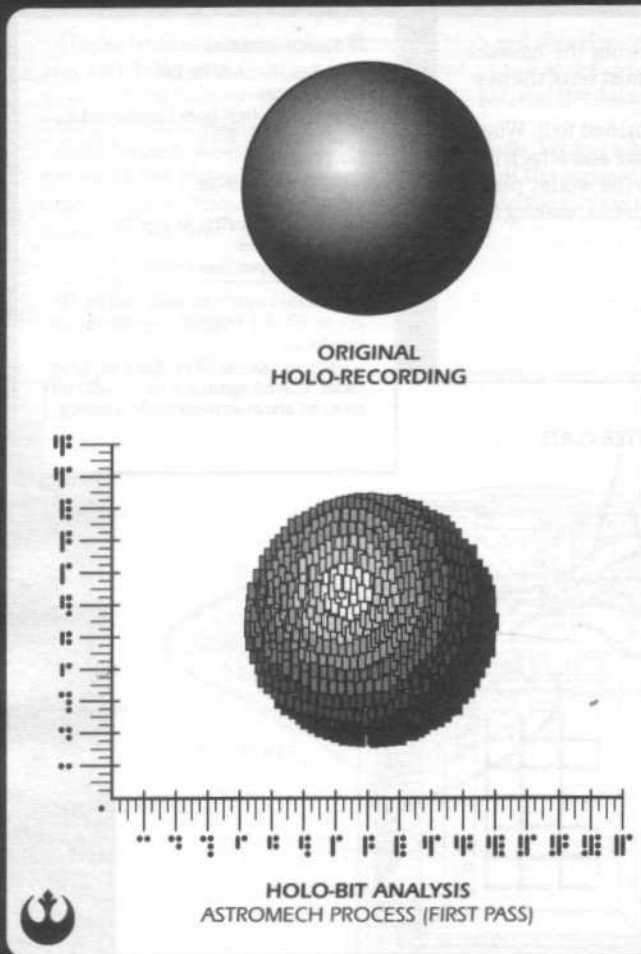

To make a pre-recorded false image of a holo-transmission, you'll need a recording of the person who you want the false image to be "from" (about a minute's worth), and an R2 unit or a portable computer with a high power rating. The trick is to enter the recording into the Droid or computer's memory, and come up with a facsimile of what you want the image to say and do. Thus, if you have a holo-image of a general saying "Let the attack begin," a false holo-image of the general could say almost anything else. The Droid or computer creates a "map" of the holo-image and then animates it, using the Holo-Bit program in this file.

■ Specifications

Item: Holo-Bit Generator

Components:

Holo-Recording
R2 Unit or Portable Computer
(Minimum Power Rating of 4D)

Skill Code:

Build: Technology
Use: Droid Programming; Con
Building Difficulty: Easy
Jury-Rig Type: No-Dice

Requires R2 unit or portable computer with minimum power rating of 4D.

Every ten seconds of holo-bit animation requires a Moderate *Droid programming* or *computer programming* roll and takes three hours to prepare. If the roll fails, it can be tried again, but another three hours is required.

The Rebel makes a *con* roll to see if the holo-bit was convincing.

■ ADDENDUM/PERSONAL ■ CRACKEN, AIREN/GENERAL..

There is no way to do this "live" because the mapping process is so complicated and time consuming. If you need this tool for a "conversation", create several varying responses, ready to run according to what the other person says. Obviously, your options will be limited in this respect.

This tool does not provide audio. If you want your image to speak, you'll need to rig up the protocol Droid unit as described in the False Voice Transmitter datafile. Sync the sound and the image, play them, record them,

and then transmit them together.

The hardest part is getting an original holo-image to use as the basis of the false image. Imperial transmissions are very hard to acquire. Once I was on board an Imperial ship and rigged a holo-recorder to the bridge's communication system. When Darth Vader made a transmission, I was able to get his picture. We were able to effectively use his image to send confusing plans to the Imperial navy.



SIMPLE LOCK PICKER

A device for picking cheap locks can be created from the ignition switch of a landspeeder or speeder bike. The switch must be of the new Volot design, which has a micro-generator.

Remove the ignition switch along with the wires attached to it. When you want to get by a lock, remove the lock's cover plate and attach the pos cable to the lock's boreen, and the neg cable to the wetter plate. Turn the ignition on. This will short the lock's re-try circuit, making the lock easier to pick.

Specifications

Item: Simple Lock Picker

Components:

Ignition Switch from Landspeeder or Speeder Bike

Skill Code:

Build: Technology

Use: Security

Building Difficulty: As per Jury-Rigging Rules

Jury-Rig Type: Non-Lethal

Increases user's *security* skill by 1D, 2D, or 3D. A 1 triggers any alarms on the door.

Only works on Very Easy or Easy locks. If used against a more difficult lock, an alarm automatically sounds.

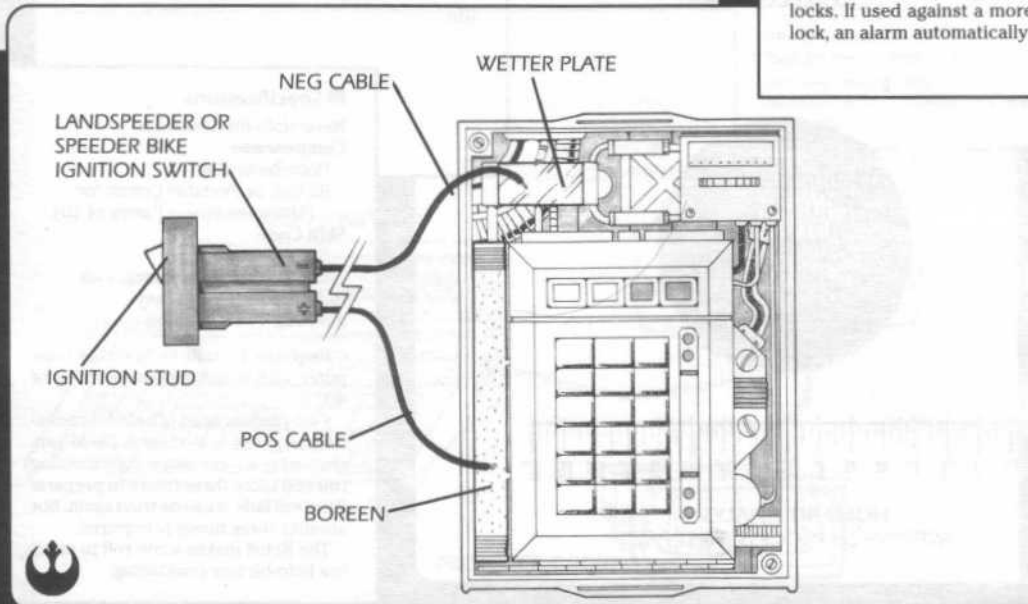

ADDENDUM/PERSONAL ■ CRACKEN, AIREN/GENERAL..

Most cheap locks are designed for show, to discourage typical people from entering private places. They are not designed to keep desperate people out. Rebels are often desperate people.

This is very simple technology being applied against simple locks. However, some high security locks are

designed to look like simple locks. I've seen Imperial locks like this. They know that we take cocky pride in our ability to outsmart them, and they sometimes encourage us to become overconfident.

DEFEATING A MAGNETIC SEAL

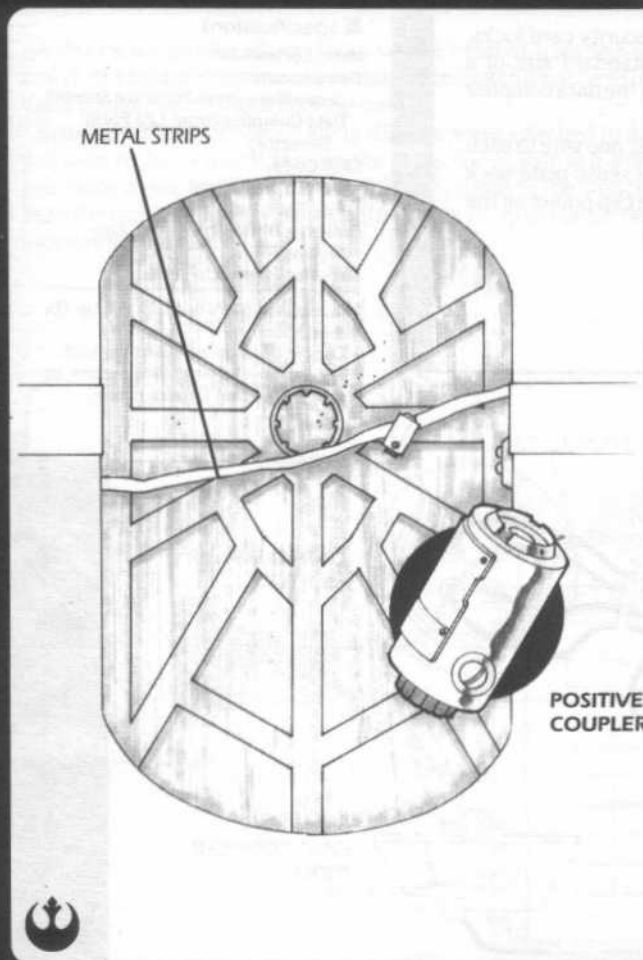

A chamber that is magnetically sealed is difficult to get out of since blaster fire is not only ineffective but becomes dangerous to everyone in the room.

To render the magnetic seal inoperative, you'll need to have a positive coupler and something that can be turned into long strips of metal. I suggest a ration container because one is usually at hand.

Cut the metal container into long strips and connect the ends together to form one long strip. Wedge the ends of this long strip into the tiny gaps surrounding the door of the room. Then place the flow stream side of the coupler against the metal strip. This will short the magnetic pulse flowing along the walls of the chamber and bring the seal down.

■ Specifications

Function: Defeating a Magnetic Seal
Components:

Positive Coupler (from any Droid, vehicle or computer)
Long strip of metal

Skill Code:

Build: Technology
Use: Device's Skill Code

Building Difficulty: Moderate

Extra dice added separately as per Jury-Rigging rules

Jury-Rig Type: No-Dice or Non-Lethal

Magnetic seal should have a difficulty number. Average difficulty is 10. Basic device has 3D to beat difficulty. Without additional dice, device is No-Dice

1D, 2D, or 3D may be added as per jury-rigging rules. Device is Non-Lethal if extra dice are added.

Device burns out if any roll is failed.

■ ADDENDUM/PERSONAL ■ CRACKEN, AIREN/GENERAL..

I've never been in a situation where I needed to know how to do this, but Captain Skywalker asked me if there was a way to get out of this kind of situation.

STORMTROOPER CHANNEL SCANNER

To turn a captured headset from stormtrooper's helmet into a channel scanner, you'll need to wire the headset to a sabacc cheater chip. Download the data code sequence from file B893a in this datafile into the sabacc chip. This will translate the chip's data about cards into the frequency code sequences of stormtrooper headsets.

When you attach the sabacc cheater to the headset, the cheater will read the changing frequency patterns. The chip will determine which frequency will probably be used next, but the data will come out in the form of a game of sabacc, so the user must know the game. If the Rebel can match the frequency, all transmissions will come over clearly.

■ **Specifications**
Item: Stormtrooper Channel Scanner
Components:
DH107 Stormtrooper Headset
Sabacc Cheater Chip
Skill Code:
Build: Technology
Use: Gambling
Building Difficulty: Moderate
Jury-Rig Type: No-Dice

Chip tells user what frequencies stormtroopers are likely to use next. Character must make Moderate *gambling* roll to understand chip's guesses. The roll can only be made once every five minutes. If successful, the headset picks up the channels being used by the stormtroopers for five minutes.

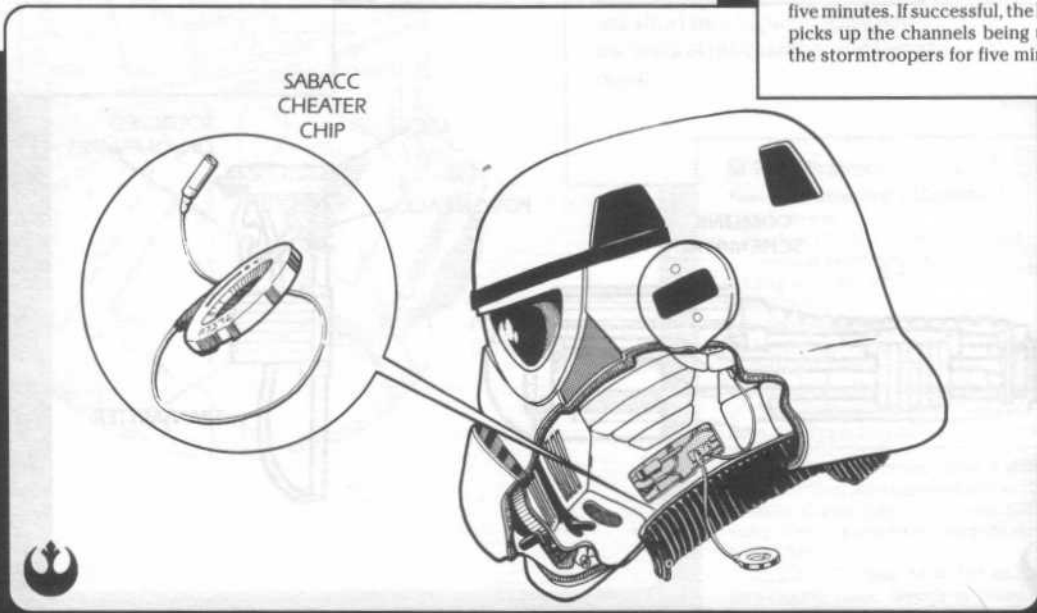

■ **ADDENDUM/PERSONAL** ■ **CRACKEN, AIREN/GENERAL..**

Herzfall Corporation's DH107 headset is a marked improvement over SoroSuub's DH77 stormtrooper headset, but it still has several exploitable flaws. One of these is the ability to track down which channel the stormtroopers are talking on and listen to their transmissions.

Every stormtrooper's headset automatically switches frequencies every few seconds to shake off unauthorized receivers. Each platoon's shifting transmission sequence is linked so the members of the platoon can always stay in touch.

If a stormtrooper's helmet is removed by anyone other than the stormtrooper, the helmet's decoding sequence breaks down and no longer follows the patterns of the platoon.

There is small switch that the stormtrooper must throw with his tongue before removing the helmet to prevent the decoding sequence from being erased.

The sabacc cheater gets around this problem. I was just fooling around with a stormtrooper helmet and a chip once while stationed on a boring garrison duty. I got some strange results, which I pursued. I discovered that the rest of the stormtrooper's platoon was sneaking up on my base and sounded the alarm just in time to turn their ambush into a victory for us.

There is probably a better way to monitor the frequencies, but heavy research into the subject might tip off the Empire.



REPLACEMENT PROSTHETICS

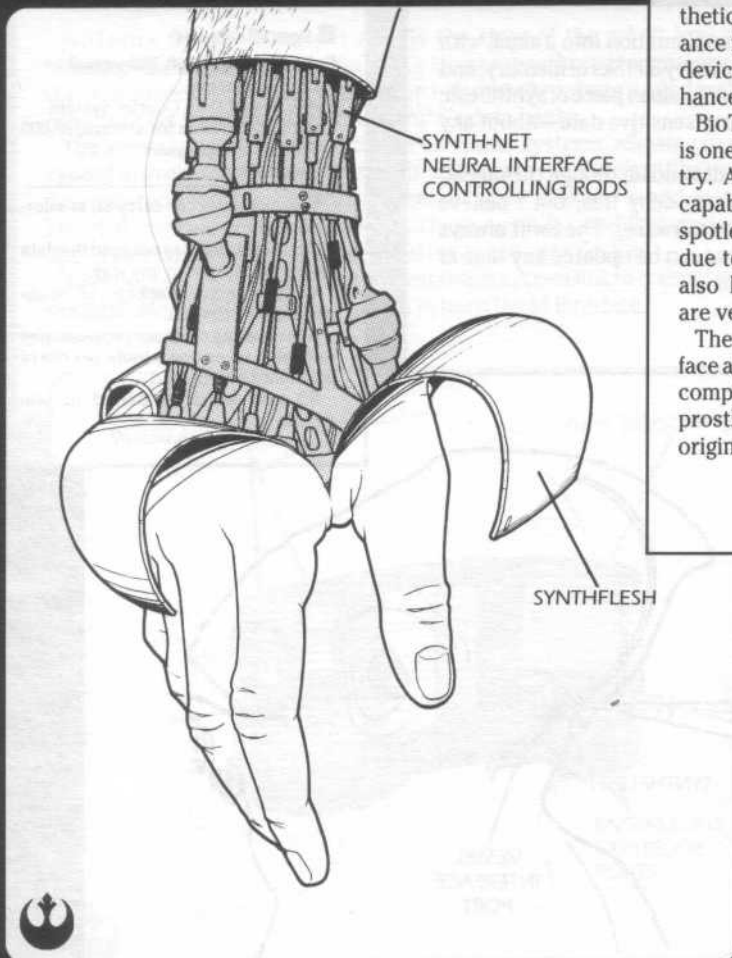

This is an example of the basic prosthetic, issued throughout the Rebel Alliance for limbs lost in the line of duty. The devices replace lost limbs, but do not enhance the body's performance.

BioTech's Repli-Limb line of prosthetics is one of the most dependable in the industry. Although these replacements aren't capable of super feats, they have a nearly spotless record for host tissue acceptance due to hyperflesh construction. They are also legal, while enhancement products are very carefully regulated.

The prosthetic's synth-net neural interface allows full control of the limb, with the complete range of tactile sensations the prosthetic's recipient experienced with his original limb.

■ Specifications

Replacements: BioTech Repli-Limb Prosthetic Replacements
Cyber Points: 1 Per Replacement
Availability: 4

The following costs include the basic prosthetic and operation:

| | |
|-------|---------------|
| Hand | 1,000 credits |
| Arm | 2,000 credits |
| Leg | 2,000 credits |
| Eye | 2,750 credits |
| Ear | 2,750 credits |
| Heart | 5,000 credits |
| Lungs | 4,000 credits |

■ ADDENDUM/PERSONAL ■ CRACKEN, AIREN/GENERAL..

Prosthetic limbs, such as the BioTech Repli-Limbs, are sold in "template" form. That is, the basic design is purchased in the form of a metal cap that can be fitted to the recipient's body. The template contains the wiring for the prosthetic, as well as its basic shell. During the operation, the neuron jacks must be grown for the recipient.

The recipient of the prosthetic is placed inside a rejuvenation tank. While in the tank, the template first creates the neuron jacks necessary to connect the pros-

thetic to the actual nerves of the recipient. It then runs countless checks for host body rejection. Slight microchanges are made in the nature of the neuro-jacks, refining their construction until the connection is accepted by the host. A series of checks are conducted every few hours to insure the host accepts the limb. The template then constructs the synthflesh covering to match the recipient's flesh tone and muscle build. The new flesh's design is drawn from the actual genetic code of the recipient.

DATA SEARCH ■ PROG40046 ■ FILEPATH 9011/29P//EQP ADB//SC ■ FILEFORM..D.PAD/DOWNLOAD
SOURCEFILE: CRACKEN'S REBEL FIELD GUIDE ■ SECTION FIVE: PROSTHETICS ■ DESIGNATION..

SWIFT 78B VESSEL COURIER SYSTEM

This vessel system guarantees a clean implantation into a skull, with no interference to the spinal column. It can carry 800 Sks of memory, and the interface jack is tiny enough to tuck under a small piece of synthflesh. A vessel system is an excellent way to carry sensitive data without any obvious mechanical assistance.

The machine's speed allows for a quick download, though the upload often calls for patience (BioTech engineers deny this, but I believe there's a problem with the Swift's system software). The Swift always comes with a virus protection package that can be updated any time at any BioTech facility for a fee of 50 credits.

Specifications

Enhancement: Swift 78B Vessel Courier System

Type: Vessel Data Courier System

Cost: 5,000 Credits for system, 20,000 Credits for operation

Cyber Points: 2

Vessel system can carry 8D of information.

Vessel courier may not read the data or interact with it in any way.

Virus protection package can be updated for 50 Credits.

After beating *computer programming* difficulty, takes one minute per die of information to upload.

8D may be downloaded in one minute.

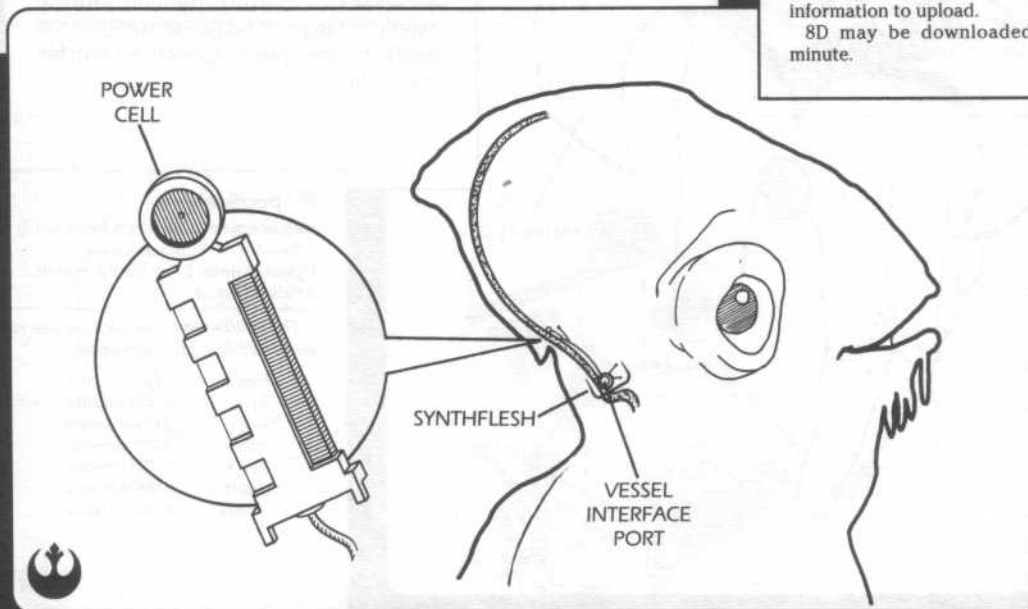

ADDENDUM/PERSONAL ■ CRACKEN, AIREN/GENERAL..

A vessel can sneak into a room full of computers stuffed with Imperial data, call up a file he wants, jack his vessel device into the computer and upload the file.

A vessel is just that — he can store a great deal of computer information within his skull, but he cannot interact with it. He often has no idea of what he is carrying within his internal data stores, and usually doesn't want to know. A vessel is usually no more than a courier. The information is downloaded into his biocomp hardware, and when he reaches his destination it is emptied out. Vessel couriers are usually very

strong and well trained in combat skills. Invariably they are carrying important data from one point to another. A vessel's job is to make sure the data gets there safely.

Most vessels are owned by one company, but some are freelancers who hire their services out to several companies. The pay is good (1,000 to 10,000 Credits a run), but risks are high. Vessels don't usually run into trouble, but when they do the combat is fierce.

PREVIOUS

DATAPAGE: 30

NEXT



BIOTECH BORG CONSTRUCT AJ^6

BioTech's Cyborg Construct AJ^6 is the state of the art in brain/biocomp interfaces. Utilizing BioTech's latest neurothread technology, the system provides a clean connection between the cyborg's mind and computer data contained within the AJ^6's data banks.

The system provides a direct link to computer systems, allowing the cyborg to program with greater ease. In addition to the standard library data incorporated into a cyborg implant, it is now possible to add data knowledge cartridges into the system. These versatile cartridges can be added and removed to the cyborg system as the user desires.

All cyborg systems allow the user to establish a direct link to computer systems. Most systems have a built-in cyborg/Droid interface.

■ Specifications

Enhancement: BioTech Borg Construct AJ^6

Type: Basic Cyborg Construct
Cost: 80,000 Credits for unit, 70,000 Credits for surgery. 400 Credits cheaper if without cyborg/Droid interface

Cyber Points: 3

Increases computer programming/repair by 2D.

Increase any Knowledge or Technical skill 1D.

Construct can store up to 8D worth of additional information.

Cyborg can read the data in his data banks at any time.

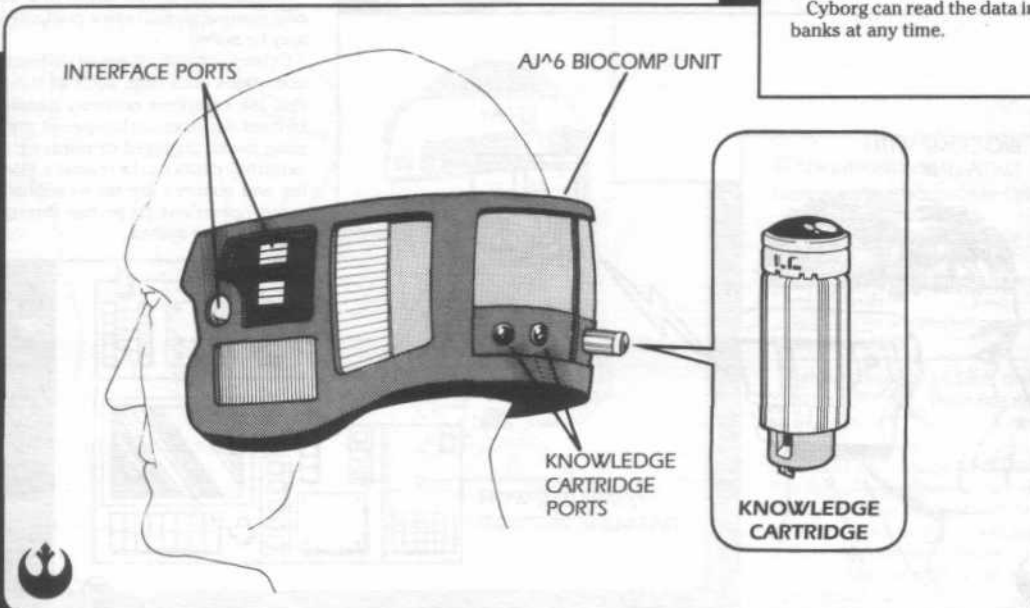

■ ADDENDUM/PERSONAL ■ CRACKEN, AIREN/GENERAL..

The biocomp implant allows the borg to interface directly with computers, computer data, and computer programs. Over time, the person's mind begins to lose more and more of its human personality. As the links between the biocomp hardware and the biological neurons grow more and more solid, the person thinks more and more in the terms of machine codes and mathematics. I once met Lobot, Lando Calrissian's former assistant on Cloud City. Never had I encountered someone so alert to all that was happening around him and yet so distanced. The slightest movement of my

hand would draw a flicker from his eyes, and yet he stood silently during my whole meeting with the Cloud City mining guild.

Most constructs are compatible with the At-Computer Link, which allows a comlink connection to a mainframe in the immediate area. This allows the cyborg to access data without actually having to make a physical connection. The computer link must be bought separately.

Unlike vessel constructs, cyborg construct hardware cannot be hidden. It's simply too big.

CYBORG/COMPUTER SYSTEM DATA-LINKS

The Crozo Industrial Products At-Computer Link allows cyborgs to link up with computer systems via a data-link network. This allows a cyborg to access computer files and programs with a long range broadcast and receiver unit.

The cyborg can only access a computer system that has been wired to accept transmission from his implants. This means that for a cyborg to access his ship's computer system by data-link, the ship's computer must have a data-link system built into it. If the ship is very big, it may be necessary to run data-link relay stations down all of the ship's corridors so that the cyborg can keep in contact with the ship's computer at all times.

■ Specifications

Enhancement: Crozo Industrial Products At-Computer Link

Type: Allows long-range transfer of information between computer and cyborg

Range: 1000 Meters

Cost: 500 Credits (Includes link with one computer) 100 Credits for each additional computer

Cyber Points: 1 (Add 1 for each computer beyond the first)

Cyborgs can make *computer programming* rolls or give simple commands.

At-Computer Link is linked to a *specific* computer, but extra computers may be added.

Cyborgs can only manipulate simple operations on a ship, such as things that the computer normally handles by itself. Air locks can be opened, grappling hooks deployed or released, or cargo bay doors can be released. Piloting and gunnery are far too sophisticated operations to be run through the computer system.

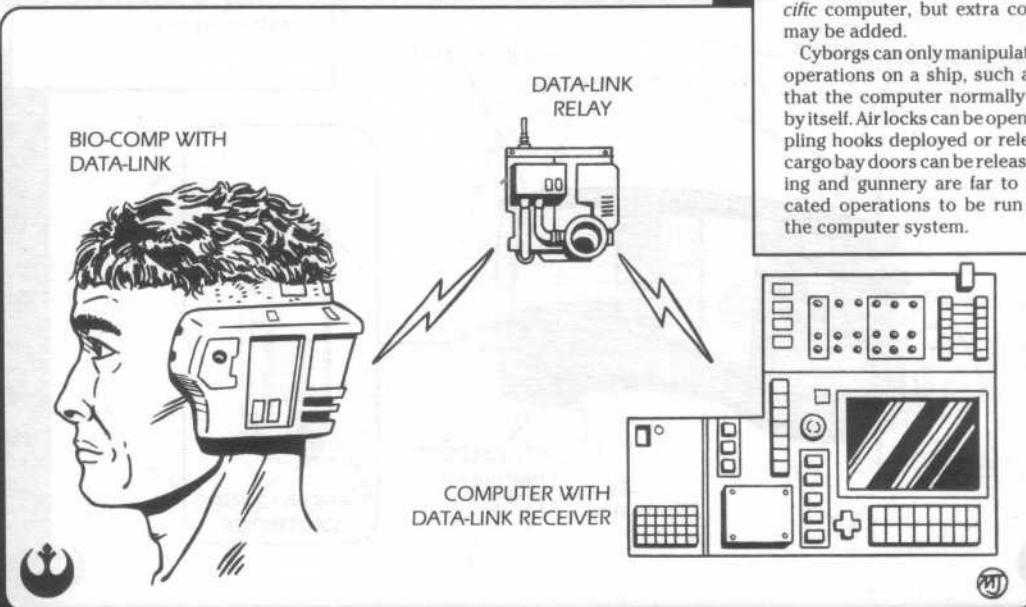

■ ADDENDUM/PERSONAL ■ CRACKEN, AIREN/GENERAL..

The At-Computer Link has a range of 1000 meters. For the data-link to work the cyborg must be within 1000 meters of the computer, or within 1000 meters of a relay station. The relay stations cannot be more than 1000 meters apart. This type of relay system is fine for a city computer system, such as the one Lobot uses on Cloud City. However, its usefulness on a starship is a little more limited.

A cyborg smuggler with strong Alliance ties once told me how his computer data-link system saved him and his ship. He'd been boarded by two Imperial customs inspectors and two stormtroopers. Their frigate, its gun trained on his ship, floated outside.

My friend and his Imperial visitors moved through the ship as he tried to prove he had no contraband on board (of course, he had contraband on board). When the two inspectors and one of the stormtroopers stepped into a cargo area with an emergency seal door, my friend told his computer to shut the door. The computer responded, trapping the three men. He then whirled around and grappled with the remaining guard. He brought the stormtrooper down, raced up to the bridge, fast-talked the frigate into thinking he was going to bring his ship over for a transfer of cargo, then shot past it and into hyperspace.

NEURO-SAAV CYBORG/DROID INTERFACE

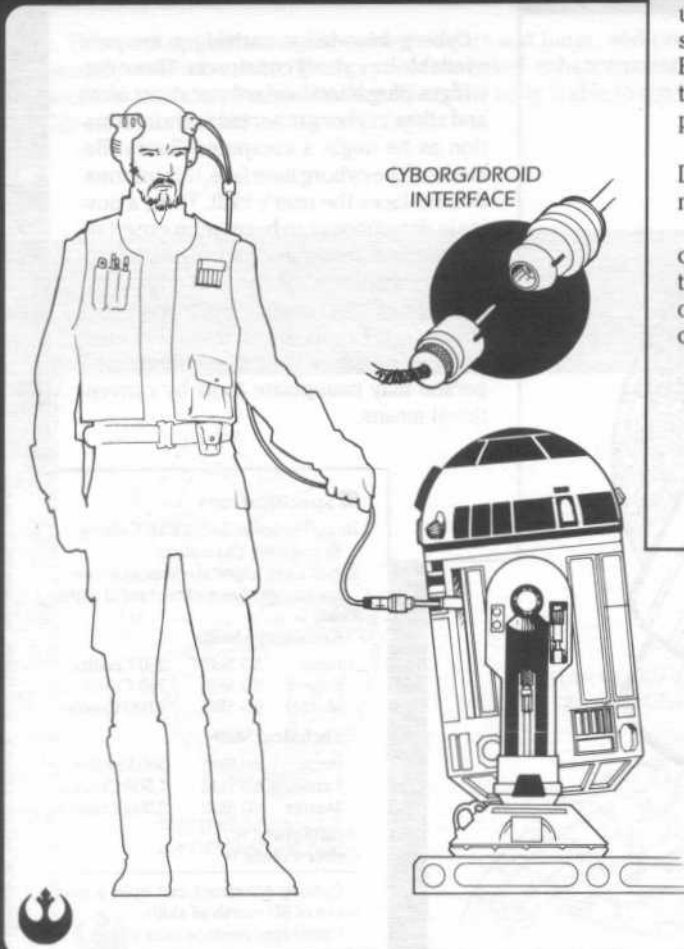

All cyborgs can link directly with Droid units, even R2 units and other Droids not specifically designed for communication. Establishing the link requires nothing more than running a cable from the cyborg implants to the Droid's communication port.

Once linked, the cyborg can speak to the Droid, as well as draw memories or information from the Droid.

The interface allows the cyborg to exchange information quickly or manipulate the Droid. It is a much more effective means of communication than the use of spoken commands.

■ Specifications

Enhancement: Neuro-Saav Cyborg/
Droid Interface

Type: Cyborg/Droid Interface

Cost:

Normally included with cyborg
construct
600 Credits if installed separately

Cyber Points: 0

Cyborg/Droid interface makes all
Droid programming rolls one difficulty
level easier.

Use the computer programming diffi-
culties listed on page 44 of *Star Wars:
The Roleplaying Game* if the cyborg is
trying to learn something the Droid
does not want to share, although the
difficulty is one level easier.

Interface is standard on most cy-
borg implants.

■ ADDENDUM/PERSONAL ■ CRACKEN, AIREN/GENERAL..

This is an excellent means of getting information from a hostile Droid. Most Droids are very good at hiding information. After all, often you don't know what you're looking for. If the Droid is very intelligent, it can hide

data under layers of machine code. The cyborg interface puts the person and the Droid on the same level.

PERZOME SOFTWARE CYBORG KNOWLEDGE CARTRIDGES

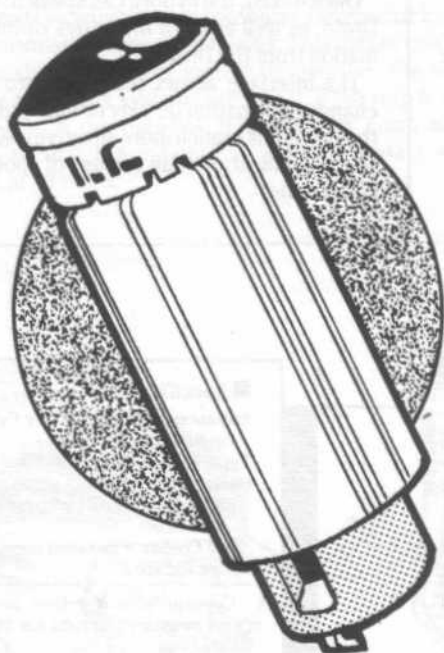

KNOWLEDGE
CARTRIDGE



Cyborg knowledge cartridges are now available for cyborg constructs. These cartridges plug into standard construct slots and allow a cyborg to access extra information as he might a computer library. Because of the cyborg interface, this information replaces the user's skill. Thus, a novice in *demolitions* can become an expert by slapping in a *demolitions* cartridge. Because of the complexity of the cartridges, the cyborg construct cannot link to any other computers, Droids or perform other functions while using a cartridge, although the person may manipulate tools by conventional means.

■ Specifications

Item: Perzome Software Cyborg Knowledge Cartridges

Type: Cartridges are available only for knowledge and technical skills.

Cost:

Knowledge Skills

| | | |
|--------|----------|---------------|
| Basic | 3D Skill | 250 Credits |
| Expert | 5D Skill | 750 Credits |
| Master | 6D Skill | 1,000 Credits |

Technical Skills

| | | |
|--------|----------|---------------|
| Basic | 3D Skill | 500 Credits |
| Expert | 5D Skill | 1,500 Credits |
| Master | 6D Skill | 2,000 Credits |

Availability: R

Cyber Points: 0

Cyborg construct can hold a maximum of 6D worth of skills.

Cartridges replace user's skill.

■ ADDENDUM/PERSONAL ■ CRACKEN, AIREN/GENERAL..

BioTech's new knowledge cartridges greatly expand the flexibility of cyborg constructs. Now a person can instantly become an expert in numerous skill areas. Costs vary around the Galaxy, but the cartridges from Perzome Software are those most often found in the

larger starports. The cartridges are broken down into two types: Knowledge-based, which are made up of datafiles with articles about general subjects, and Technical-based, which center on the application of knowledge to specific technical problems.



NEURO-SAAV CORPORATION CARDIO-MUSCULAR PACKAGE

This package enhances the cyborg's heart and lungs, and provides muscle reinforcements. These rybcoarse-based enhancements allow muscles to do more work with less effort. The body is able to run faster, lift more, and withstand more damage.

■ Specifications

Enhancement: Neuro-Saav Corporation Cardio-Muscular Package

Type: Increases Strength attribute/skills

Base Cost: 800 Credits per pip

Cyber Points: 2

Operation takes one week.
Recipient must spend another week recovering and adjusting to new implants.

Doctor must make three *Difficult medicine* rolls over the week of the operation for successful implantation.

If any of the rolls fail whenever the character makes a *Difficult* or *Very Difficult Strength* or associated skill roll, the character must make a second *Difficult Strength* roll. If this second roll fails, the character's muscles contract and the character falls prone for 2D minutes.

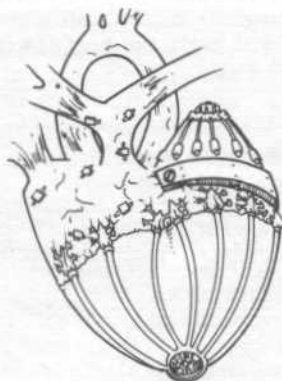

NEURO-SAAV Q-2
ARTIFICIAL HEART



NEURO-SAAV EX-MUSC
ENHANCEMENT

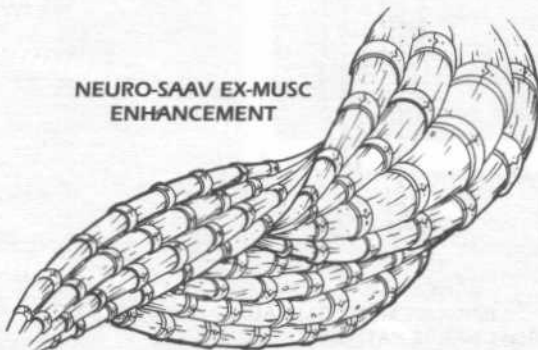

■ ADDENDUM/PERSONAL ■ CRACKEN, AIREN/GENERAL..

This is a very dangerous enhancement package. People with this package have a tendency to believe that they are invincible and immune to damage. After a while, this takes a tremendous psychological toll. Most people

who get this enhancement are already on the edge. Often, its enough to send them over.

Getting this package is like trying to cheat the universe. And trust me, the universe knows.



DATA SEARCH ■ PROG40046 ■ FILEPATH 9011/29P//EQP.ADB//SC ■ FILEFORM..D.PAD/DOWNLOAD
SOURCEFILE: CRACKEN'S REBEL FIELD GUIDE ■ SECTION FIVE: PROSTHETICS ■ DESIGNATION..

'GENEERING RESPONSE IMPROVEMENT PACKAGE (RIMPACK)

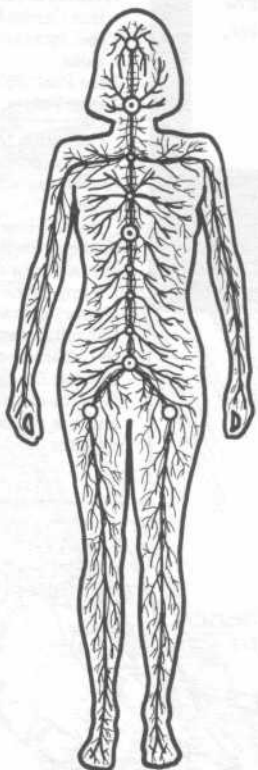

'GENEERING RESPONSE
IMPROVEMENT PACKAGE
GROSS NERVE-PATHWAY SCHEMATIC



While this package dramatically improves one's coordination, it is very expensive and dangerous to implant. Utilizing the finest neural-web reflex threads (reportedly woven by hand by the Poraskors of Betal), this bio-impulse interface allows quicker responses in combat situations.

Installation of this package requires risky surgery. The threads must be sewn into the recipient's body, and traced out in the bollen pattern (see Trisk's Medo-thermal Guide) so that every muscle is connected to the wires. This entire network of threads is then tied into the brain of the recipient. This is the very dangerous part, for the surgeon must essentially recreate a new nervous system interface without damaging the original one.

■ Specifications

Enhancement: 'Geneering Response iMprOVEMENT Package (RIMPack)

Type: Increases Dexterity attribute/skills

Base Cost: 700 Credits per pip

Cyber Points: 2

To install, the doctor must make three Difficult *medicine* rolls over the week of the operation for success.

If any of the rolls fail, the character becomes highly agitated, or *hyperactivates*, whenever he rolls a 20 or higher with a *Dexterity* related skill.

During hyperactivation, the character is overwhelmed with sensory input for 2D minutes and is controlled by gamemaster. The character may attack friends or foes, flee the scene or be hypnotized with fear.

■ ADDENDUM/PERSONAL ■ CRACKEN, AIREN/GENERAL..

Of all the dangerous cyborg enhancements, this package is probably the most self-destructive. The body wasn't designed to carry hardware like this. A botched operation can go unknown for years, and then, SNAP!, the cyborg can become an irrational, destructive machine.

A person with 'Geneering's iMprOVEMENT package behaves as if he's got eyes all over his head. The RiMPack heightens a person's ability to receive sensory input and apply the information. I've heard stories of

some people with this package who were barely able to control their actions. Every sound and shifting shadow demanded an immediate physical response. It's almost as if they're paranoid, and yet these people report not feeling any fear. Their bodies are responding faster than they are even aware.

A low-powered increase isn't nearly as dangerous. The problems mentioned above usually occur when someone has gone way beyond the physical capabilities he was used to.

← PREVIOUS

DATAPAGE: 36

NEXT →



DATA.SEARCH ■ PROG40046 ■ FILEPATH 9011/29P//EOP.ADB//SC ■ FILEFORM..D.PAD/DOWNLOAD
SOURCEFILE: CRACKEN'S REBEL FIELD GUIDE ■ SECTION FIVE: PROSTHETICS ■ DESIGNATION..

SOROSUUB MOTION INTERFACE PACKAGE

SoroSuub's motion interface package contains add-on hardware and software that lets a cyborg interface directly with starship computer systems. By communicating directly with either the ship's piloting controls, weapons systems, or shielding systems, it is possible to operate ship's systems with greater ability. The package can also be used to increase performance on repulsorlift craft and even beasts.

The hardware and software are designed around Holo3-Graphic's Multi-Motion computer framework. The cyborg is able to retain the relative position of dozens of objects, including his own position, the velocity of his vehicle, enemy vehicles, important terrain features (boulders, asteroids), and so on.

■ Specifications

Enhancement: SoroSuub Motion Interface Package

Type: Increases Mechanical attribute/skills

Base Cost: 400 Credits per pip

Cyber Points: 2

INTERFACE VISION

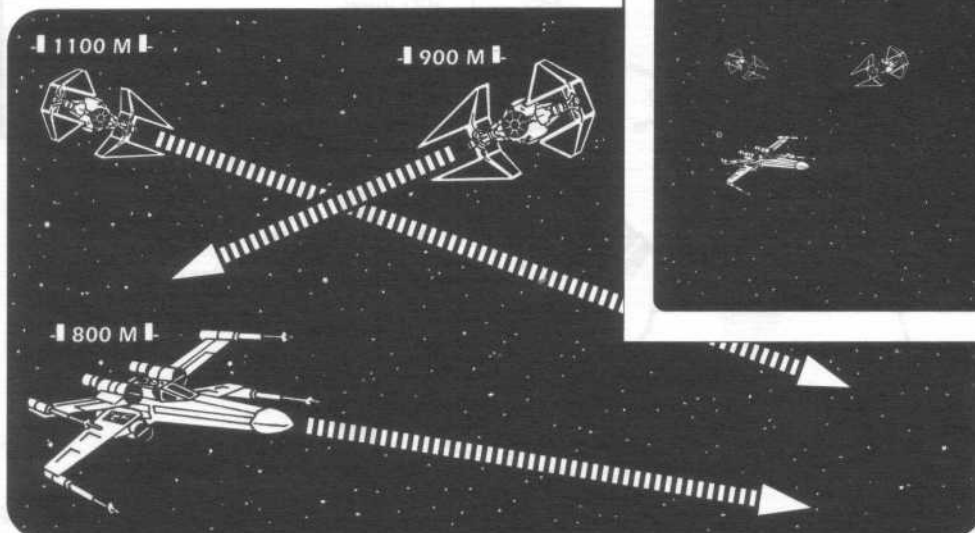

NORMAL VISION

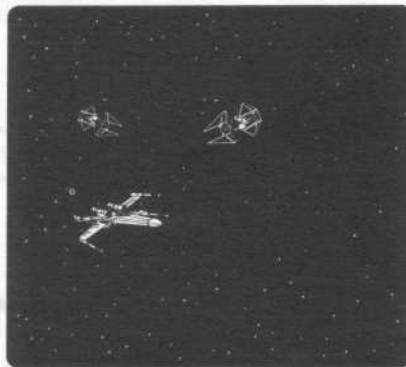

■ ADDENDUM/PERSONAL ■ CRACKEN, AIREN/GENERAL..

This package is the rage among disreputable hot shot pilots. Supposedly, the package makes the galaxy look more like a vid-game than real life. Obstacles and targets appear to have an electric glow to them, and enemy and friendly craft are color-coded for immediate reference. Probable courses are plotted, targeting computers can automatically lock in on anything within a weapon's field of fire and the interface examines flight patterns of foes. All of this gives the user a better chance to determine what will happen during battle.

Like many sensory enhancements, the users report that they begin to find normal life dull. Some of the cyborgs with this package are drawn to combat, which

is when the brilliant graphics are most intense. This fascination normally results in the premature death of the individual.

When using the package on a ship or a repulsorlift craft, the cyborg must jack into whatever device he is trying to use. If he is piloting or using his shields, he has to be plugged into the ship's bridge; if he's manning the guns, he's got to be plugged into the ship's gun control system.

When beast riding there's nothing to jack into, although the benefits of the package still exist.

PREVIOUS

DATAPAGE: 37

NEXT



■ DATA SEARCH ■ PROG40046 ■ FILEPATH 9011/29P//EOP.ADB//SC ■ FILEFORM..D.PAD/DOWNLOAD
■ SOURCEFILE: CRACKEN'S REBEL FIELD GUIDE ■ SECTION FIVE: PROSTHETICS ■ DESIGNATION..

NEURO-SAAV HIFOLD SENSORY PACKAGE

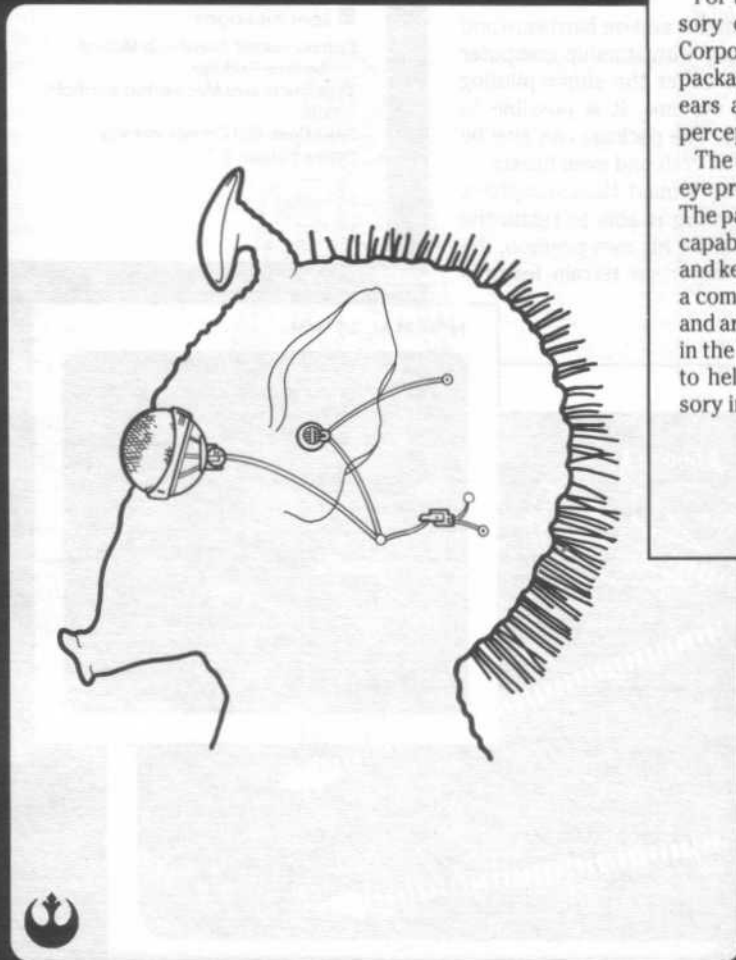

For those who need the ultimate in sensory enhancements, there's Neuro-Saav Corporation's Hifold Sensory Package. The package comes complete with enhanced ears and eyes, increasing all aspects of perception.

The Hifold system integrates the ear and eye prosthetics into an interconnected unit. The package actually increases the brain's capability to handle the extra input of data and keep it organized. This is done through a combination of true-fleck brain implants and artificial hypergleamum glands placed in the brain. The glands release chemicals to help the recipient understand all sensory input.

■ Specifications

Enhancement: Neuro-Saav Hifold Sensory Package
Type: Increase Perception attribute/skills
Base Cost: 400 Credits per pip
Cyber Points: 2

■ ADDENDUM/PERSONAL ■ CRACKEN, AIREN/GENERAL..

This package is a thinking person's enhancement. While it doesn't increase a person's ability with a blaster, it does let the user read people's body language much better. The user becomes acutely aware of how a

person's breathing is changing or if their eyes are shifting in new ways. Be warned that anyone with this package will be able to interpret this data to tremendous advantage.

← PREVIOUS

DATAPAGE: 38

NEXT →



CONTROL ZONE REPULSE-HAND

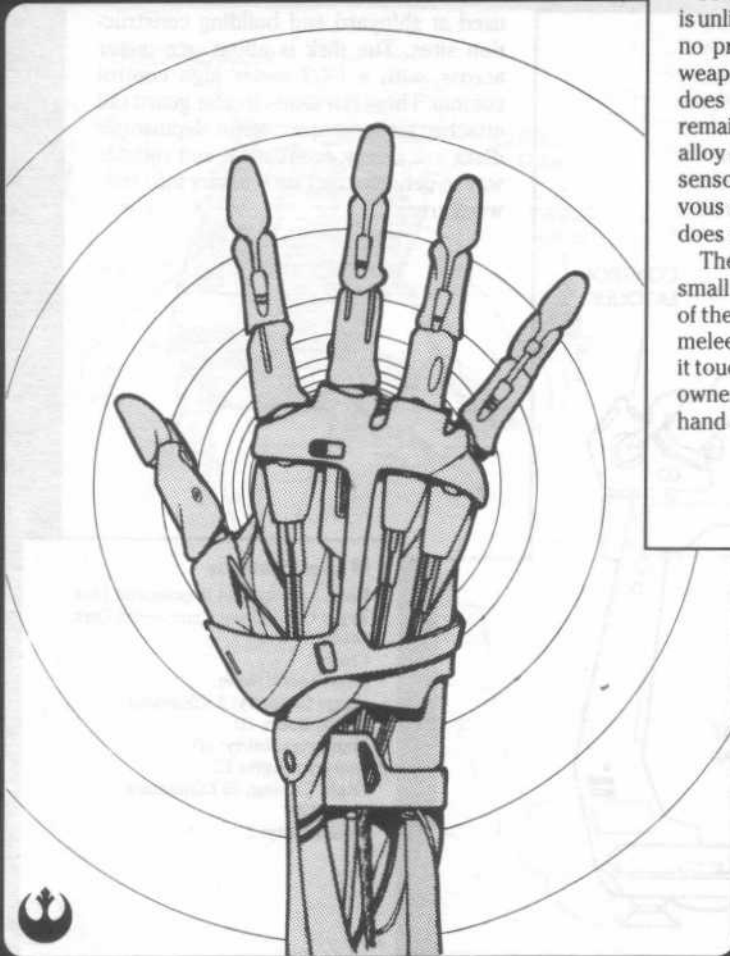

Control Zone's repulse-hand prosthetic is unlike other prosthetics because it makes no pretense of being a real hand. It is a weapon and nothing else. The template does not grow synthflesh, so the hand remains silver-blue, the color of the temporary alloy material. The hand does not have a sensory interface into the recipient's nervous system. Thus, the owner of the hand does not feel pain or other stimuli.

The repulse-hand prosthetic contains a small repulsor-generator inside it. Because of the repulsor-generator, the hand forces melee weapons out of the way even before it touches the weapon—and this gives the owner of the hand an edge in combat. The hand can be used to parry melee weapons.

■ Specifications

Enhancement: Control Zone Repulse-Hand

Base Cost: 300 Credits per pip (Minimum cost 1,500 Credits)

Cyber Points: 2

Repulse-hand adds 1D to *repulse-hand* damage.

User gains *repulse-hand* skill at 0D. Must buy *repulse-hand* skill to equal or greater than *Strength*.

Skill and damage are set at time of purchase and may not be improved at a later date. Skill replaces *brawling* and *brawling parry* and may be used for *melee parry*.

For example, if a character wants to buy a repulse-hand at 4D+2, it will cost 4,200 credits.

■ ADDENDUM/PERSONAL ■ CRACKEN, AIREN/GENERAL..

This brutal weapon is the mark of a being who has no concern for the law or morality. It is a weapon, pure and simple. Isn't it enough that we must carry machines of destruction around with us all the time; that we must live

and sleep in starships bristling with arms? This is a permanent mutilation of one's body. Bounty hunters, assassins and ruthless thugs often get this enhancement, but at great cost to their spirit.

ARATECH A14 REPULSORLIFT DISK

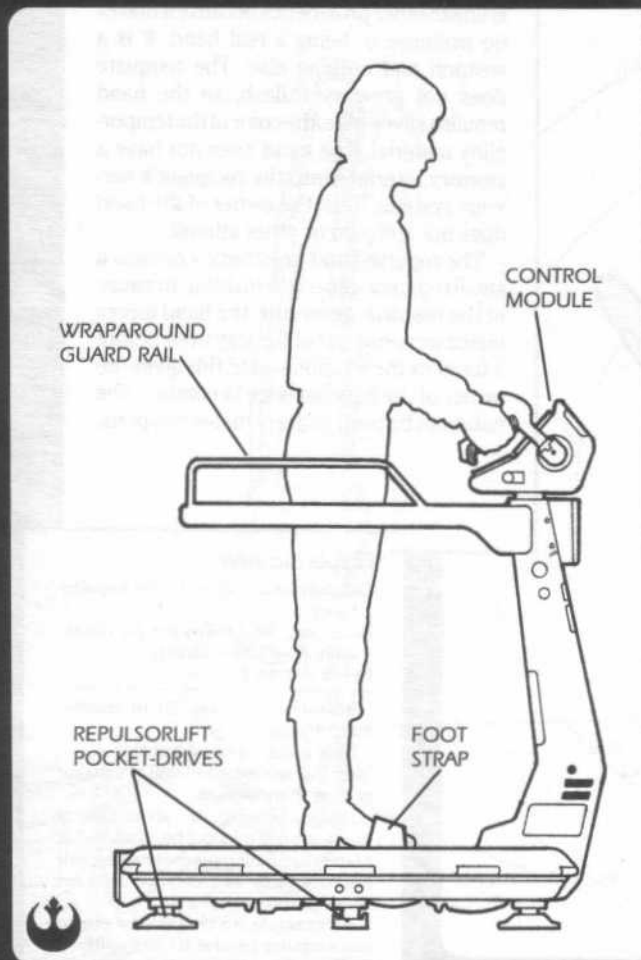

The repulsorlift disk is a one man vehicle used at shipyard and building construction sites. The disk is about one meter across, with a 1-1/2 meter high control column. There is a semi-circular guard rail attached to the control column. Repulsorlift disks are a very economical and reliable way to get construction workers into awkward areas.

■ Specifications

Item: Aratech A14 Repulsorlift Disk
Type: One-Person Repulsorlift Disk
Scale: Speeder
Crew: 1
Passengers: None
Cargo Capacity: 2 Kilograms
Speed Code: 1D
Maneuverability: 1D
Body Strength: 1D
Flight Ceiling: 25 Kilometers
Cost: 300
Availability: 2

■ ADDENDUM/PERSONAL ■ CRACKEN, AIREN/GENERAL..

These vehicles weren't made for combat and you'll seldom ever use them unless you're in a work area. I've included them in this book because I've used them in combat situations and someday one of you may have to.

Luckily, my experience wasn't much of a firefight (the disks don't hold up well against any damage). I'd been sent to the KDY shipyard on Rasterous to get some information about the new Imperial Star Destroyer (this was a while back). I was nosing around a warehouse when some guards spotted me. There was a repulsorlift disk next to me, so I jumped onto it and took off. The guards were near some disks as well, so the chase was on.

It was one of the strangest chases I've ever been in. We slipped between the stacks of crates all over the warehouse. The disks are not very fast, so it was more strategy than a true chase. They'd hear my disk and zip over to my direction. I'd hear them and shut down and then, under low power, duck around them. We barely saw each other at all.

Finally I made it to the warehouse's door and slipped out. As far as I knew, they continued to look for me for hours after I left.



ARATECH SCREAMER JUMPER JET PACK

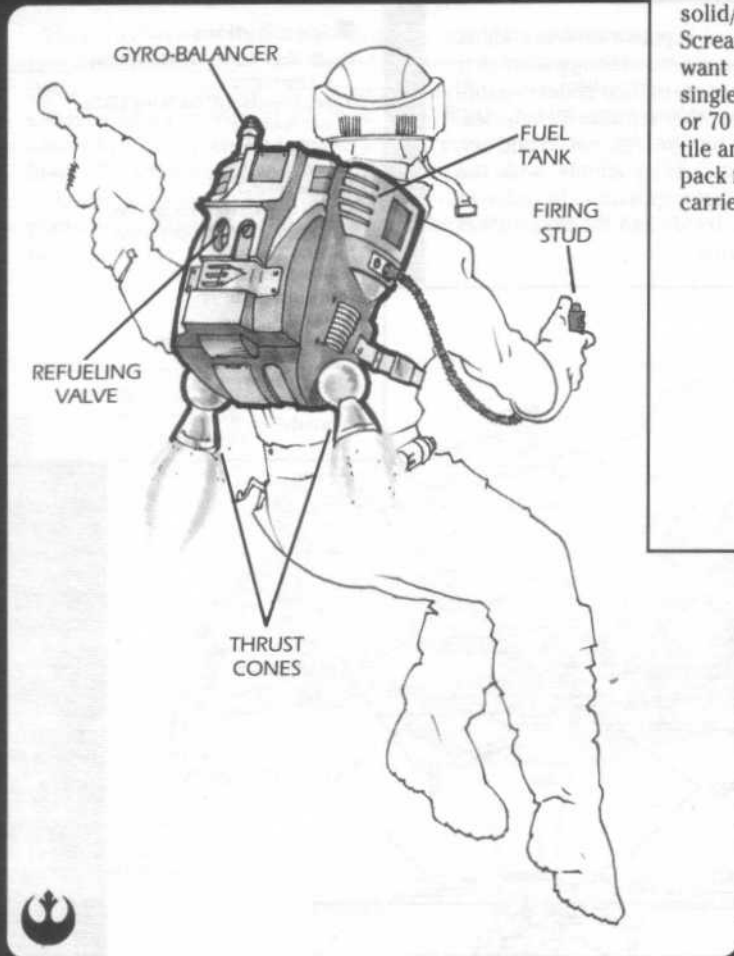

Designed with a fiberlight chassis and solid/liquid fuel adaptors, the Aratech Screamer is the favored unit for those who want altitude in a hurry. Able to carry a single passenger 100 meters horizontally, or 70 meters vertically, the pack is versatile and worthy of the Aratech name. The pack fires in single increment bursts, and carries enough fuel for 10 jumps.

■ Specifications

Item: Aratech Screamer Jumper Jet Pack
Type: Personal Jet Pack
Scale: Character
Skill Code: Dexterity or Mechanical
Availability: 1
Cost: 250 Credits
Fuel: 50 Credits

Fuel capacity for 10 bursts.
Carries single passenger 100 meters horizontally or 70 meters vertically.
Can slow descent to prevent injury from falling, requiring one burst per 200 meters fallen.
After each burst the engine must be allowed to cool for one round.
Requires Easy *Dexterity* or *Mechanical* roll to use.
May carry up to 75 kilograms of cargo, or another passenger, but distance travelled is halved.

■ ADDENDUM/PERSONAL ■ CRACKEN, AIREN/GENERAL..

The Jumper jet pack is a good machine, but it suffers because the engine only uses single burst firing. You must let the engine cool for ten seconds after each burst

or it will overheat and burn out. The loud exhaust limits its use in covert actions, but it can be a handy escape mechanism when there aren't any vehicles handy.



■ NEN-CARVON R-444 IMPERIAL SKY SWOOPER

Nen-Carvon's first entry into the field of repulsor-driven craft is promising. The sky swoopers are repulsor-augmented hang gliders that have a blaster mounted above the pilot. Because of their glider capability, the noise level is much lower than most other repulsorlift vehicles.

The Sky Swooper is controlled by using a bar the legs rest on and two hand grips attached to each wing. Flight is fairly simple, with the repulsorlift motor making long distance flights possible. In order to steer the vehicle, the pilot must use both hands and his legs, so it is difficult to use the blaster while maneuvering.

■ Specifications

Craft: Nen-Carvon R-444 Imperial Sky Swooper
Type: Repulsor/Para-Wing Glider
Scale: Speeder
Length: 4 Meters
Crew: 1
Passengers: 0
Cargo Capacity: 2 Kilograms
Skill: Repulsorlift Operation
Speed Code: 2D
Maneuverability: 4D
Body Strength: 1D
Weapons:
Light Blaster Cannon
Fire Control: 1D
Damage: 2D
Cost: 400 Credits
Availability: R

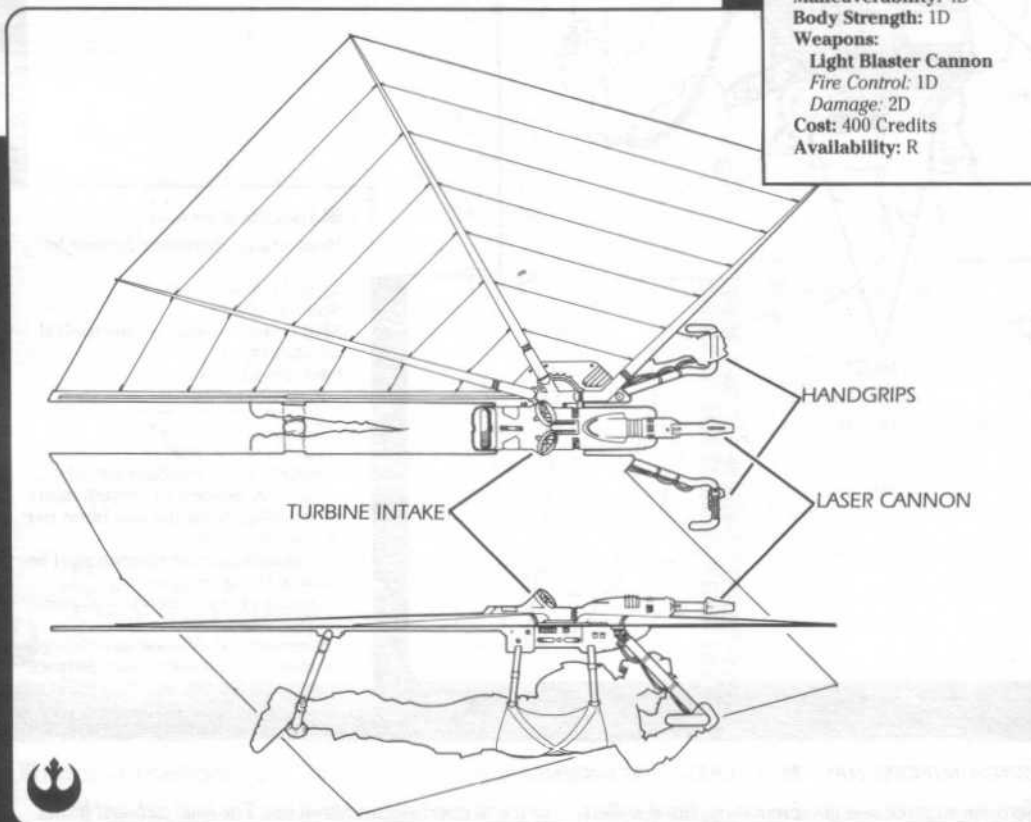

■ ADDENDUM/PERSONAL ■ CRACKEN, AIREN/GENERAL..

Based on the para-wing gliders of Cloud City, the sky swoopers are now standard issue for stormtroopers involved in stealth raids. They are also used for patrols in areas with great altitude changes due to terrain, such as the forest world of Aris, or the great canyons of Ebra.

When the vehicle is kept at a low speed, it is fairly easy to control. I remember the first time I used one: it was a sky swooper I'd stolen from an Imperial base during an

escape. I kicked in the repulsorlift engine to get away as quickly as possible. When the extra speed came up, I rushed toward the huge trees and nearly died three times within the span of second. It was fun. It was exhilarating. It was foolish. I'm half tempted to try the vehicle again someday.

HYDROSPEARE CORP. EXPLORER SUBMERGIBLE

These underwater vehicles are designed solely for underwater exploration and combat. They are built of lightweight link-steel with burthan threads. The craft are very maneuverable and durable. Explorer submergibles can withstand pressures of 8000 bps (on many worlds, nearly five kilometers underwater), and travel up to 85 kilometers per hour. The vehicles moves by scuttling across the ocean floor. Their weighted sponce-grip legs can maneuver through rocky surfaces and grab a secure foothold when necessary. The machines stand six meters tall.

■ Specifications

Craft: Hydrospeare Corp. Explorer Submergible
Type: Undersea Exploration Vehicle
Scale: Walker
Length: 9.1 meters
Crew: 4
Passengers: 2
Cargo Capacity: 500 kilograms
Consumables: 1 week
Speed Code: 2D
Body Strength: 3D
Weapons:
Heavy Blaster Cannon
(Forward Mounted)
Fire Control: 1D
Damage: 5D
Light Blaster Cannon
(Turret Mounted)
Fire Control: 1D
Damage: 2D

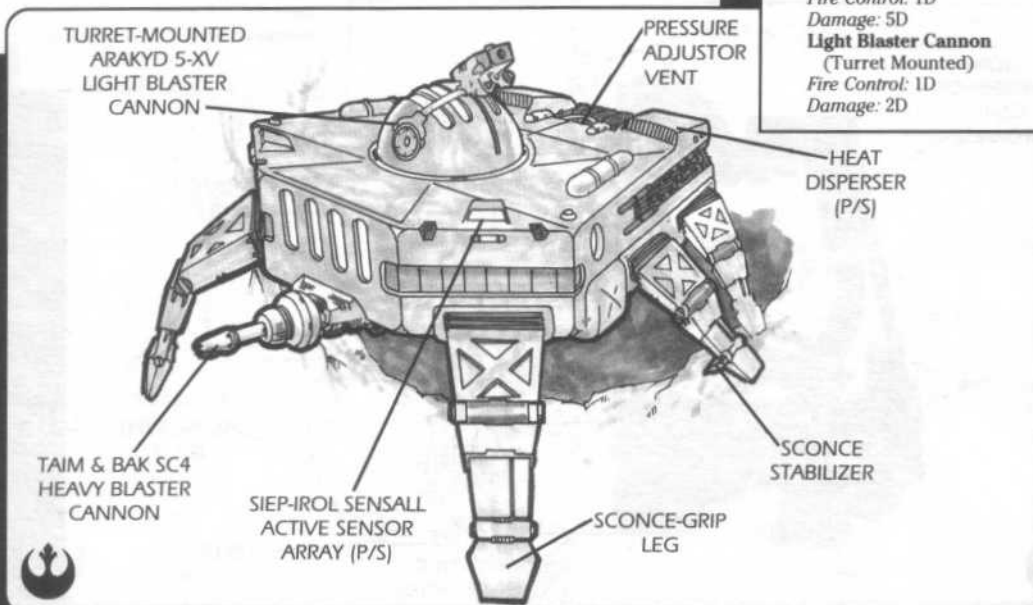

■ ADDENDUM/PERSONAL ■ CRACKEN, AIREN/GENERAL..

The Explorer submergible was requisitioned by the Empire. It was supposed to be an amphibious assault vehicle, capable of travelling both underwater and on land. Hydrospeare's design team was unable to get the vehicle swift enough underwater and mobile enough on land to meet the Empire's dual criteria. The Empire opted for the underwater design.

The drawbacks of the submergible are its cramped space for the crew. Although the craft is supposed to have room for two passengers, anyone travelling in the passenger area must ball themselves up and remain stuffed in a small cubbyhole for the duration of the trip. The crew doesn't have it much better, with everyone but the turret gunner lying on their bellies. Entrance to the device is through a pressurized hatch located under the craft.

■ DATA SEARCH ■ PROG40046 ■ FILEPATH 9011/29P//EQP.ADB//SC ■ FILEFORM..D.PAD/DOWNLOAD
■ SOURCEFILE: CRACKEN'S REBEL FIELD GUIDE ■ SECTION SIX: VEHICLES ■ DESIGNATION..

☯ CORELLIAN ENGINEERING CORPORATION ESCAPE POD

The escape pod is an essential part of any starship. All capital ships and luxury liners have them, as well as most freighters. Pods are activated by entering them and pressing a simple control stud. When the button is pressed, the hatch seals and the pod is fired from the ship. If no world is nearby, the pod moves a safe distance from the ship in case of an explosion (normally 5,000 meters) and broadcasts a distress signal at three second intervals.

If there is a planet nearby, the pod will conduct a quick planetary life support survey. If the planet can support life, the pod will chart a path to an environmentally safe area and drop to the planet's surface.

■ Specifications

Craft: Corellian Engineering Corporation Escape Pod
Type: Escape Pod
Scale: Starfighter
Crew: None
Passengers: 6
Cargo Capacity: 18 kilograms (personal gear for six)
Consumables: 1 Week (for six passengers)
Hyperdrive Multiplier: None
Nav Computer: None
Hyperdrive Backup: No
Sublight Speed: 0D
Maneuverability: 0D
Hull: 1D
Weapons: None

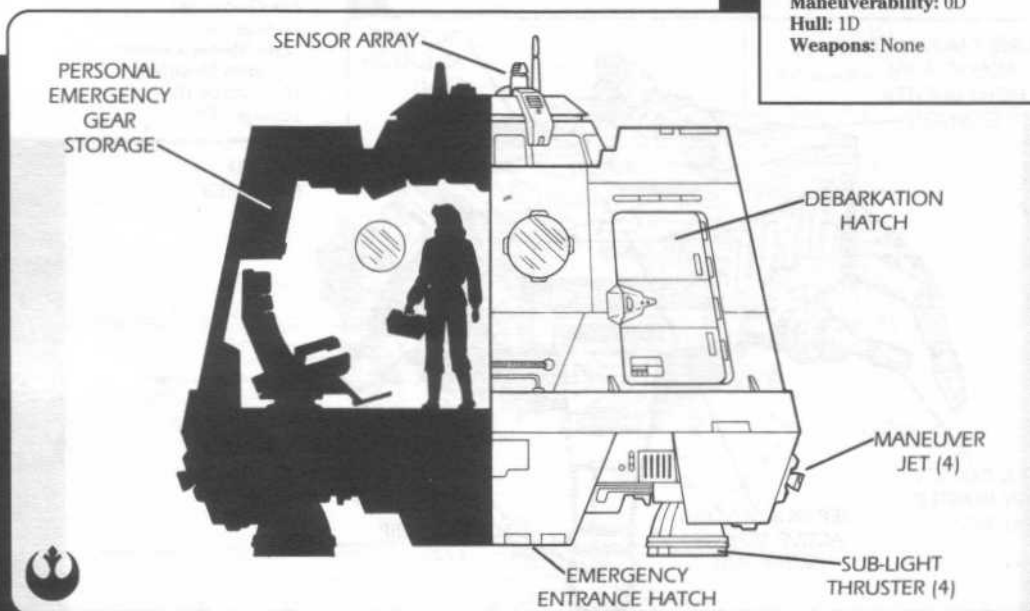

■ ADDENDUM/PERSONAL ■ CRACKEN, AIREN/GENERAL..

Originally escape pods gave the passengers the option of landing on a planet deemed survivable by the pod's computer. The problem was that, for whatever reason, most people felt they would be safer in a pod in the middle of space than they would be on a planet they'd never set foot on before.

This, however, is the reverse of the truth. As long as the computer system is accurate (and the Corellian comput-

ers are especially good), if it tells you the planet is safe, then the planet is safe. The problem with waiting for help or bickering about landing is that the pods carry limited food and medical supplies. People stand a better chance on a hostile planet than in the cold of space. The passengers must get down to the planet as quickly as possible so they may enhance their supplies.

◀ PREVIOUS

DATAPAGE: 46

NEXT ▶



ANIMAL RESTRAINING BOLT

It's possible to make the equivalent of a Droid restraining bolt for animals. The device makes it easier to ride animals and get them to do what you want.

To make the device, you need a Droid master unit and restraining bolt. Take the ionization pulse elements out of the bolt and replace them with a small, self-filling auto-hypodermic (MedCo's needles work just fine if you're looking for something cheap). The hypo should be filled with A Vrassa or Pleezer (two pleasure causing drugs found in most medical kits). The device dispenses the chemical on command, similar to a small treat for behaving correctly.

Wire the auto-hypo into the pulse slots of the bolt. The hypo connectors won't fit perfectly, so you'll have to connect them by wire.

Specifications

Item: Animal Restraining Bolt

Components:

Droid Restraining Bolt and Master Unit

Auto-Hypodermic

A Vrassa or Pleezer

Scale: Character

Skill Code:

Build: Technology

Use: Beast Riding

Building Difficulty: As per Jury-Rigging Rules

Jury-Rig Type: Vehicle

Increases character's *beast riding* skill 1D, 2D, or 3D.

Master has a 50-meter range.

If the gamemaster rolls a 1, the animal bucks, and a Moderate *beast riding* roll is required to keep the animal under control.

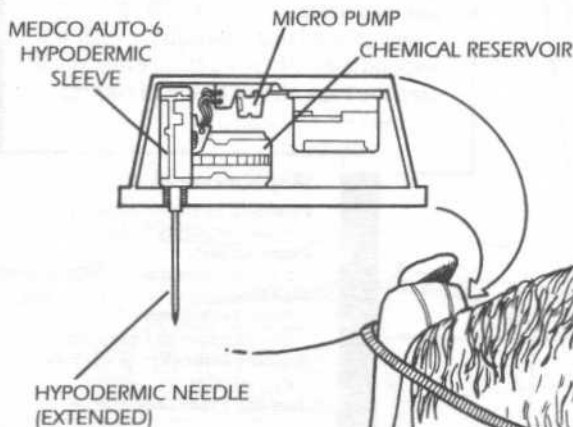

ADDENDUM/PERSONAL ■ CRACKEN, AIREN/GENERAL..

There are a few other beast control devices on the market, but they're rather harsh on the animal. I prefer mine because it removes pain as a motivation, which most of the other devices depend on.

You can build the device for a varying amount of control. Let me just warn you, however: the more you

push your beast with this device, the better the chances that you'll run into trouble. Even when the chemical causes pleasure, few animals appreciate being jabbed with needles. Also, the more you rely on this device, the less the animal trusts you and your ability.

CUSTOMIZING AIRSPEEDER CONTROL FLAPS

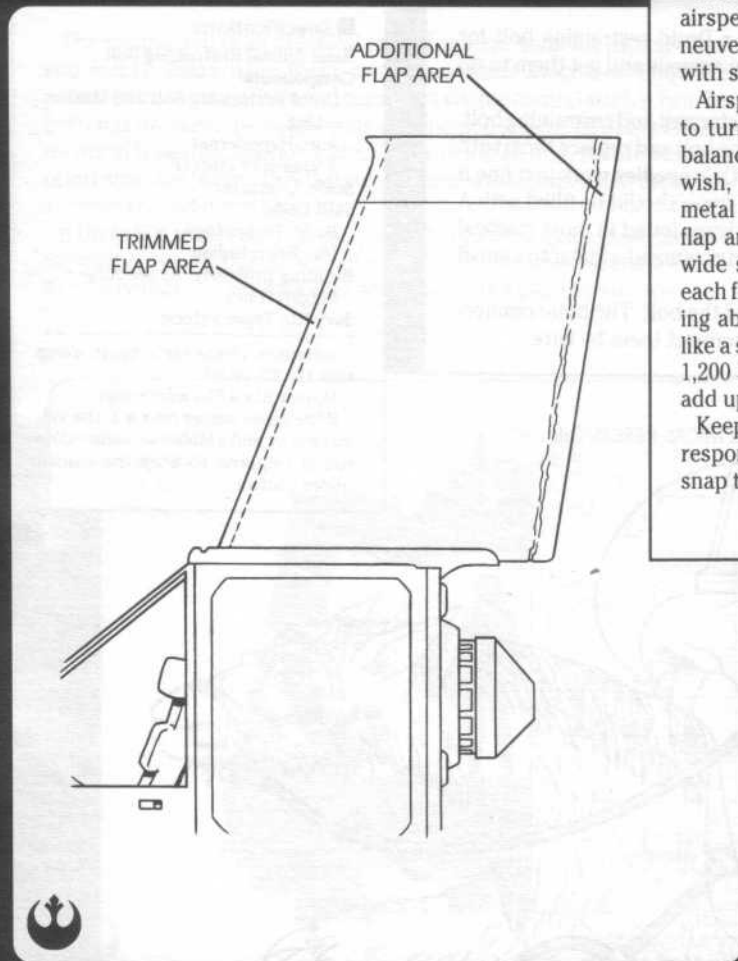

Although the aerodynamic design of airspeeders makes them incredibly maneuverable, seldom are people satisfied with stock performance.

Airspeeders depend on mechanical flaps to turn. The flaps have been designed to balance turning speed with safety. If you wish, you can shave one centimeter of metal off the inside edge of each control flap and add a one and a half centimeter wide strip of metal to the outer edge of each flap. Each added strip increases turning ability, but sacrifices safety. It seems like a small change, but when you're going 1,200 kilometers per hour small changes add up quickly.

Keep in mind that although the craft will respond faster, there's a chance that you'll snap the flaps off and fly out of control.

■ Specifications

Function: Increases Airspeeder Maneuverability Code

Components:

1-1/2 centimeter wide strips of metal

Skill Code:

Build: Technology

Use: Repulsorlift Operation

Building Difficulty: As per jury-rigging rules

Jury-Rig Type: Vehicle

Increases airspeeder maneuverability code 1D, 2D, or 3D.

■ ADDENDUM/PERSONAL ■ CRACKEN, AIREN/GENERAL..

I came up with this plan after I was trapped on a world the Empire had just invaded. The place was crawling with stormtroopers and TIE fighter patrols. My airspeeder and I were hidden inside a cave that was part of a winding maze of canyons. I was running out of food, and I knew the Rebel carrier was going to be leaving in a few days. Due to the distance, I could only reach it by my airspeeder. I knew, however, that if I used my airspeeder there was a good chance I'd be spotted and lead the Imperials to the escaping ship. I'd be able to lose the Imperials within the winding canyons, if I could outma-

neuver them. For a full day I took measurements and made calculations and came up with these changes for the control flaps.

I jury-rigged the airspeeder, popped inside, and took off. Three TIE fighters were after me in a moment. My airspeeder was now better at flying through the canyons than the fighters were, and by taking wild chances with my piloting I was able to escape while they ended up flying into the canyon walls. Before any other fighters were scrambled, I was clear and on my way to the shuttle.

Ⓜ AIRSPEEDER AFTERBURNER POWER INCREASE

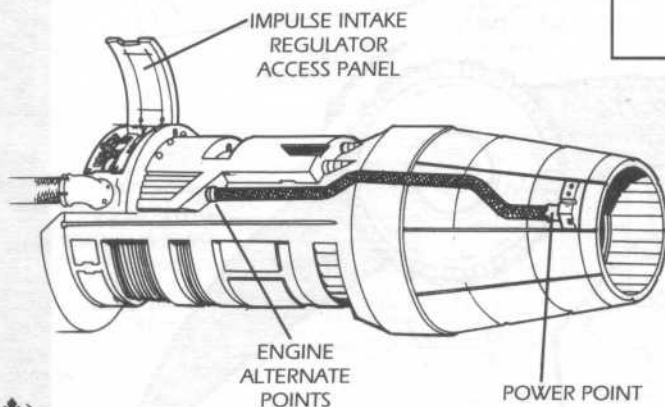
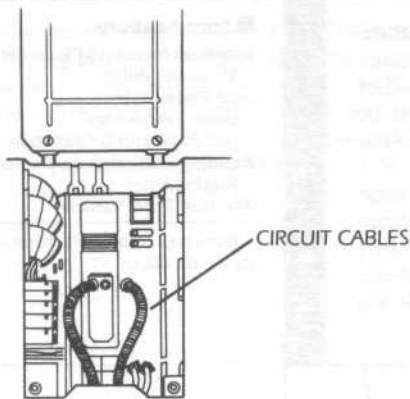

Some airspeeders, such as the T-16 Skyhopper, have afterburner engines for increased speed. These burners can be rigged for even greater speed than the engineers intended. Several methods exist for this; none are safe. But here's the most prudent:

Cut the circuits on the impulse intake regulator. Then wire cables (20z to 23z) from the engine to the power points on the burners (one cable to a burner).

When this is done, you will have increased the power flowing directly to the afterburners. Cut any caps that prevent melting due to excess power, because they will eliminate any added performance. Cutting the caps also means your burners can melt very easily.

■ Specifications

Function: Increases Airspeeder Speed Code

Skill Code:

Build: Technology

Use: Repulsorlift Operation

Building Difficulty: As per Jury-Rigging Rules

Jury-Rig Type: Vehicles

Increases airspeeder speed code 1D, 2D, or 3D.

■ ADDENDUM/PERSONAL ■ CRACKEN, AIREN/GENERAL..

I've never done this. I never plan to. The added speed may help you outrun someone, but that won't matter when the burners melt and your speeder spirals into the ground at full throttle.





CLOUD CAR REPULSORLIFT AGITATOR ADJUSTMENT

This adjustment to Bespin Motors cloud cars increases their maneuverability when used on non-gas giant worlds. The repulsorlift agitators on these cars are more durable and sophisticated than those of other brands. They are necessary for safe use on gas giants, but they can be loosened considerably in the less dangerous atmospheres of other worlds.

Locate the repulsorlift agitators and reduce the tension on the bearings by four to eight gats. The looser the agitator bearings, the more maneuverable the vehicle is. Keep in mind that although the agitators are vital on Bespin, they're still necessary for proper flight anywhere. The more you loosen them, the greater the chance that the vehicle will cease to function properly.

■ Specifications

Function: Increases Cloud Car Maneuverability

Skill Code:

Build: Technology

Use: Repulsorlift Operation

Building Difficulty: As per Jury-Rigging Rules

Jury-Rig Type: Vehicle

Increases cloud car's maneuverability by 1D, 2D, or 3D.

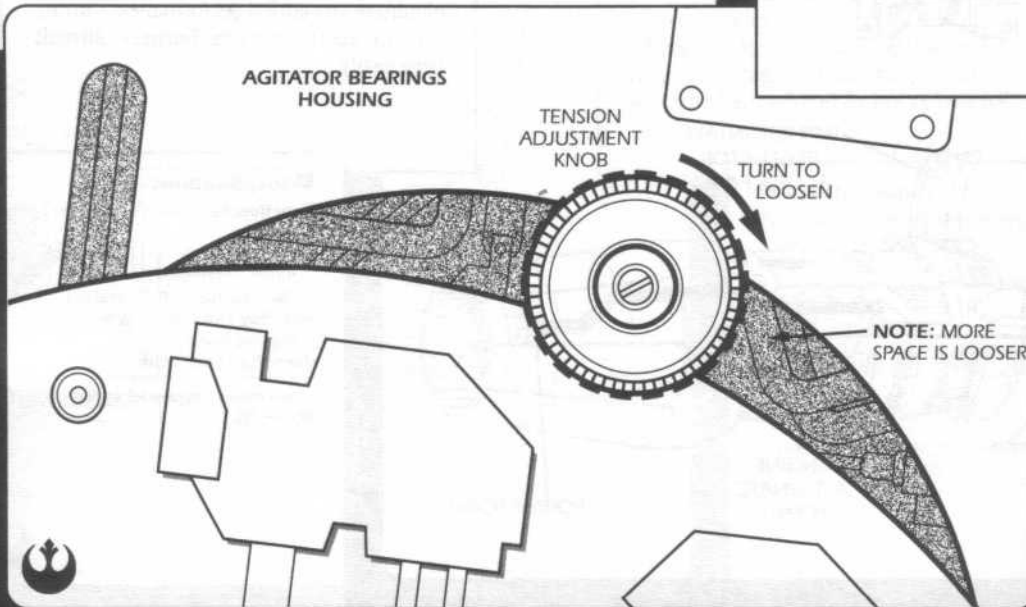

■ ADDENDUM/PERSONAL ■ CRACKEN, AIREN/GENERAL..

The cloud cars out of Bespin Motors are designed to perform at extremely high altitudes. Unlike other cloud cars, Bespin Motors cars have several features necessary to keep them safe on Bespin that are not needed on lower altitude worlds (non-gas giant planets). One of these is the craft's reinforced repulsorlift agitator, which keeps the vehicle steady in the face of Bespin's massive magnetic fields.

On a non-gas giant planet, the agitators are not as important and the bearings can be toned down. Because the agitators are integral to the design of the craft, however, care must be taken as to how much they are loosened. Personally, I would never drop them below the fourth valve.



INCREASED ION FLOW FOR CLOUD CARS

To increase the speed of the already fast Bespin Motors Storm IV cloud car, or any other ion powered cloud car, just jump up the power flow from the ion engine to the burners. To do this, rip out the the string-guard cables linking the repulsorlift generator to the engines, and replace them with silver-foils or tram-eights. Then, loosen the ion piston so that the generator produces about 400 more revs per second. This'll boost the power supply, acceleration and speed of the cloud car.

Specifications

Function: Increased Ion Flow for Cloud Cars

Components:

Silver Foils or Tram-Eights (from any swoop)

Skill Code:

Build: Technology

Build Difficulty: As per Jury-Rigging Rules

Jury-Rig Type: Non-Lethal

Increases a cloud car's speed code 1D, 2D, or 3D.

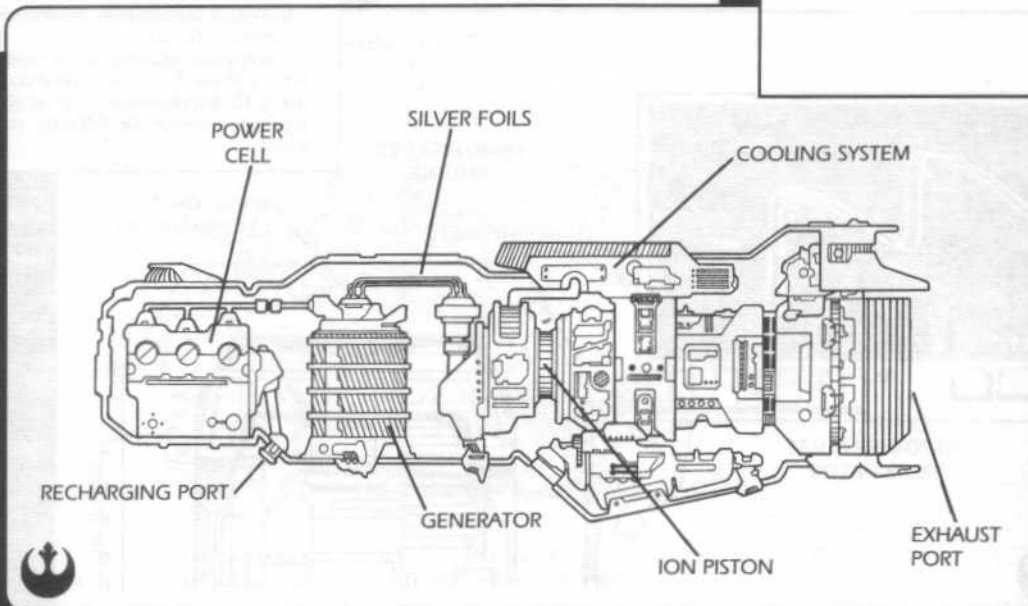

ADDENDUM/PERSONAL ■ CRACKEN, AIREN/GENERAL..

I saw this rigging performed by some Cloud City technicians when I was visiting Bespin last month. There was a ship trapped on the back of a beldon and a pack of velkers were closing for an attack. They needed to get to the beldon herd as quickly as possible.

They increased the ion flow and shot off into the pink sky of Cloud City. I didn't think any of them were going to make it back with their engines burning like that, but they did. Although the ship was lost, the crew came back safely with the cloud car pilots.

TWIN FOPAL 888 REPULSORLIFT RACK ADJUSTMENTS

To increase the maneuverability of most landspeeders you'll need to create a power loop in the repulsorlift generator's sequencing system. To do this, tune the generator's rack so it forms an echo image on a power-pulse monitor (available just about anywhere). For a Twin Fopal 888 generator, the setting should be two to three hundred albars (it varies for other craft, but you're looking for a skile curve). Once you've found it, lock the racks in place. Then, drop a suspension serbo-bracket between the racks (you can get a spare bracket out of the rear of any other landspeeder).

Specifications

Function: Increases Landspeeder Maneuverability Code

Components:

Power-Pulse Monitor
Serbo-Bracket

Scale: Speeder

Skill Code:

Build: Technology

Building Difficulty: As per Jury-Rigging Rules

Cost:

Power-Pulse Monitor: 50 Credits

Availability: 1

Jury-Rig Type: Vehicles

Increases landspeeder maneuverability code 1D, 2D, or 3D.

Power-pulse monitor is necessary for any improvement over 1D. If making a 1D improvement without the monitor, increase the difficulty two levels.

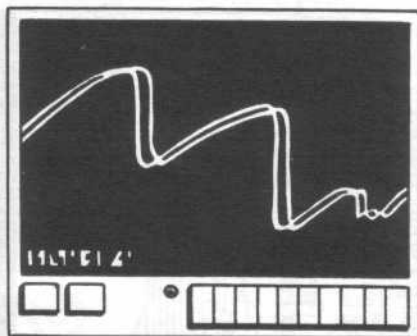

POWER-PULSE MONITOR

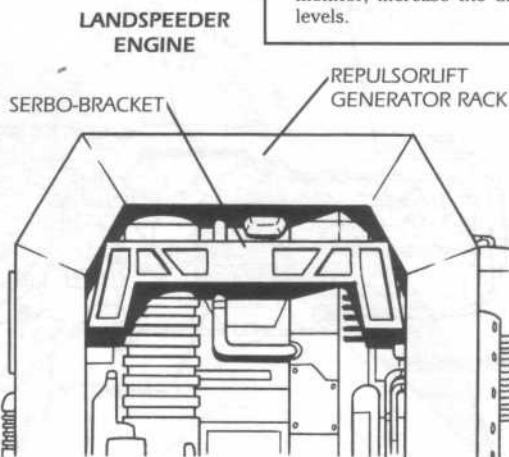

ADDENDUM/PERSONAL ■ CRACKEN, AIREN/GENERAL..

The landspeeder is more maneuverable because the racks feed each other signals immediately, rather than waiting for the ballast compensators to make adjustments for changes in direction. However, you've got to get used to a landspeeder that wants to turn wildly at the

slightest adjustment on the steering bars. Whenever I've flown a landspeeder rigged like this I found that although maneuvering was very exciting, flying straight was nerve-wracking—it took all of my energy to prevent the craft from shooting off in another direction.

LANDSPEEDER TURBOTHRUST OVERDRIVE

To increase the speed of turbobothrust-enhanced landspeeders like the SoroSuub XP-38 Landspeeder Ground Vehicle you'll need to replace the turbobothrust converter coil (usually a V5 to V9 gauge) with a V12 to V18 gauge coil. These larger coils are normally used in X-wings or Rebel Alliance snowspeeders. The higher the gauge, the greater the power increase you'll get out of the vehicle.

■ Specifications

Function: Increases Landspeeder Speed Code
Components: V12 or V18 Coil (from X-wing or airspeeder)
Scale: Speeder
Skill Code:
Build: Technology
Use: Repulsorlift Operation
Building Difficulty: As per Jury-Rigging Rules
Jury-Rig Type: Vehicle
Increases landspeeder speed code 1D, 2D, or 3D

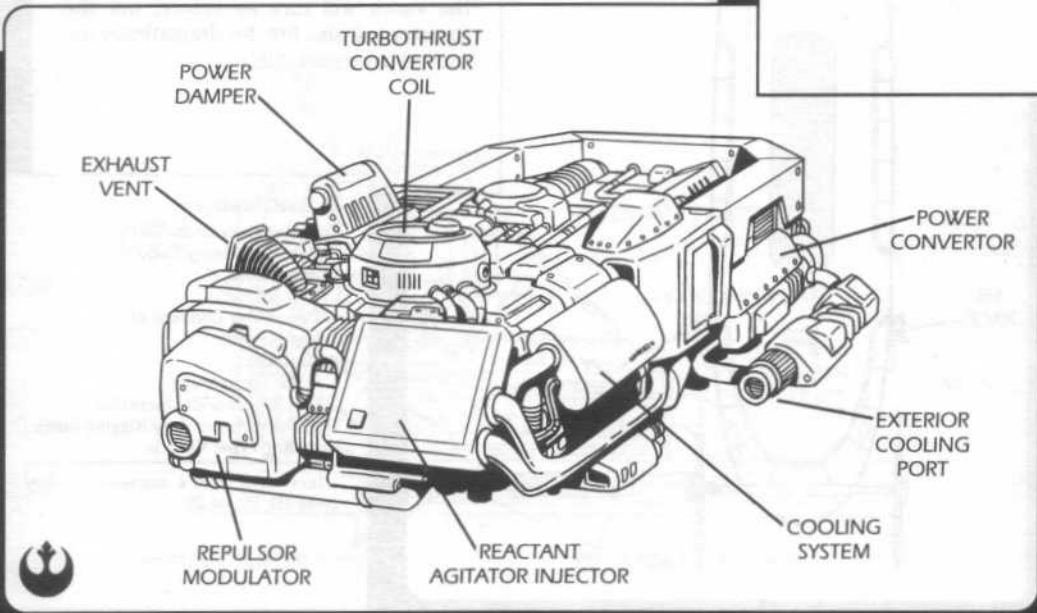

■ ADDENDUM/PERSONAL ■ CRACKEN, AIREN/GENERAL..

I'd say that half of the time I've spent in landspeeders, I needed to go faster than the speeder would go. It took me some time, but I found out how to increase the speed of a landspeeder, even if it is a really bad design idea. The converter coil carries a low gauge because the impulse fusework on the entire machine is only rated for

a 1000z buildup. My method gets extra speed, but risks shorting out the whole system. Over the years, I've had two landspeeders die on me in the middle of a chase due to my tinkering. In both those cases I tried to really pump up the speed. If you don't push the speeder too much beyond its original design, it should do just fine.

SKIFF JET PACK ADDITION

UBRIKKIAN BANTHA II
CARGO SKIFF

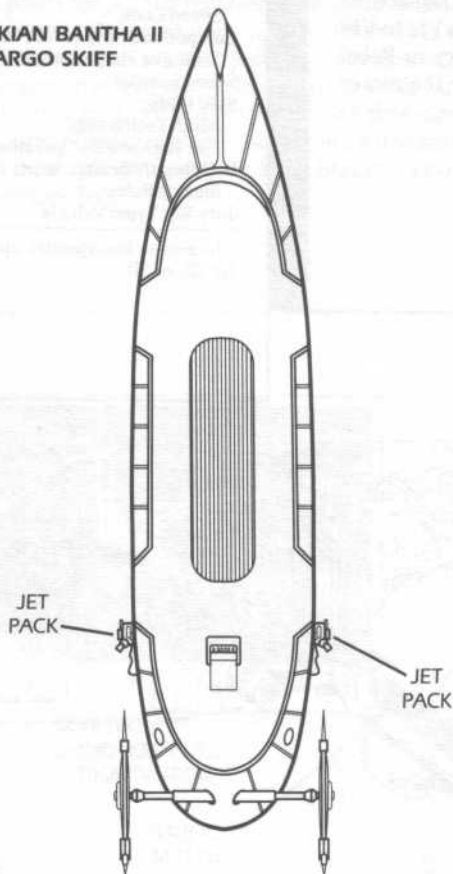

To increase the maneuverability of a skiff, plasma-weld two jet packs perpendicular to each side of the rear hull. Link the packs to the tiller controls, with the power surge cap connected to the tiller's thersop ambulator. Then, rip open the jet packs' thrust control system and wire them into the motion control system of the steering vanes. The rear edges of the steering vanes also have to be pulled back 10 degrees to compensate for the added thrust. Wire the jet packs to the skiff's power generator, adding a power convertor on the Jehltekk Enhancer Valve. When you use the tiller, the vanes will turn as before, but the thruster will also fire, for dramatically improved maneuverability.

■ Specifications

Function: Increases Skiff's Maneuverability Code

Components:

Two Jet Packs

Two Power Convertors

Scale: Speeder

Skill Code:

Build: Technology

Use: Repulsorlift Operation

Difficulty: As per Jury-Rigging Rules

Jury-Rig Type: Vehicle

Increases skiff's maneuverability code 1D, 2D, or 3D.

■ ADDENDUM/PERSONAL ■ CRACKEN, AIREN/GENERAL..

The skiff is designed to be practical, not maneuverable. A skiff's purpose is simply to slowly lug stuff from one spot to another, so there's not much need to make it capable of taking turns at high speeds.

But if you've rigged the skiff to go faster, you might as well rig it to maneuver better, too. Be warned, however, that rigging a skiff to behave like a landspeeder is really looking for trouble. The strain on the craft is far beyond its original design specifications.

Once, some stormtroopers leaped into a skiff I'd jury-rigged without being aware of the modifications I'd made on the craft. They slammed on the accelerator and brought the tiller to port. They expected a slow, methodical start, but were instead slammed to the starboard side and thrown from the skiff when it capsized.

ADJUSTING SKIFF REPULSORLIFT BALANCE TURBINES

Most skiffs are designed to favor strength over speed. To this end, skiffs are built with balance turbines that distribute the energy from the repulsorlift engine evenly around the surface of the craft. This lets the engines build up extra layers of power to support heavy weights, but prevents them from applying the energy to movement.

To get around this and increase a skiff's speed, remove the balance turbine couplers and insert the coupler ends into the engines' alternate ports. This will feed the energy back into the engines, where it will loop and create a terdon power surge.

■ Specifications

Function: Increases Skiff's Speed Code

Components:

Remove balance turbine couplers from normal mounts and inset into engine's alternate ports

Scale: Speeder

Skill Code:

Build: Technology

Use: Repulsorlift Operation

Building Difficulty: As per Jury-Rigging Rules

Jury-Rig Type: Vehicle

Increases skiff's speed code by 1D, 2D, or 3D.

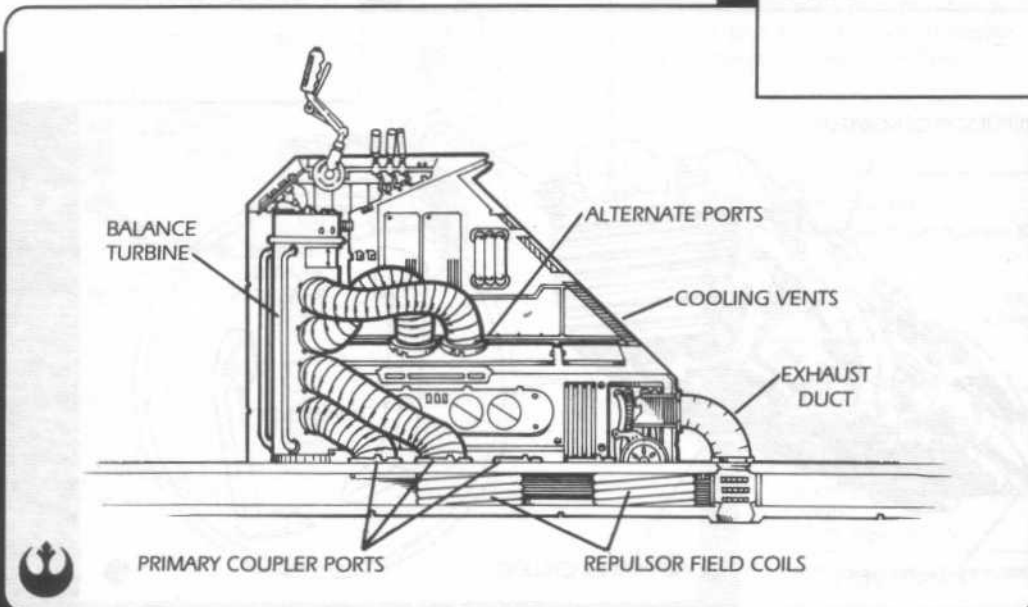

■ ADDENDUM/PERSONAL ■ CRACKEN, AIREN/GENERAL..

I remember once I had to cross a swamp filled with large fish with lots of dangerous teeth. My cargo was two power generators for a Rebel base on the other side of the swamp, and the only thing available for use was an old skiff.

Trying to beat an impending Imperial attack, I rigged the skiff for more speed, and got stuck halfway across. The skiff didn't lose power but it just wouldn't move forward. I worked on the engine for a while and finally

accepted the fact that I'd pushed the engine too hard. It was going to need more parts before it would move anywhere by itself again.

Luckily, I had some animal restraining bolts I'd built for the base. I drew the large fish to me with some food, lassoed them with cable, and fired the bolts into their backs. I captured three of them and got them to drag the skiff across the swamp. I got there later than I wanted to, but before the Imperials attacked the base.

SW SPEEDER BIKE MANEUVERABILITY ADJUSTMENTS

Aratech and Ikas-Adno speeder bikes both depend on brath bearings for their steering. These bearings allow smooth, rapid turns without loss of control. To increase the maneuverability of a speeder bike, open the rear lower engine panel and locate the brath bearing brackets. When you've found them, clamp each set with a 14k hydroclamper and squeeze each bracket in the middle until the hydroclamper gauge reads 1.8.

This loosens the safety features of the speeder bike's steering system. When you push harder on the steering, the bike will give and turn a little tighter. However, each time you force the speeder bike to turn a little too quickly, the steering system wears down a bit. Eventually the bearings will snap, sending you to a spectacular, fiery death.

■ Specifications

Function: Increases Speeder Bike Maneuverability

Components:

Two 14k Hydroclampers (from any vehicle tool kit)

Scale: Speeder

Skill Code:

Build: Technology

Use: Repulsorlift Operation

Building Difficulty: As per Jury-Rigging Rules

Jury-Rig Type: Vehicle

Increases speeder bike maneuverability code 1D, 2D, or 3D.

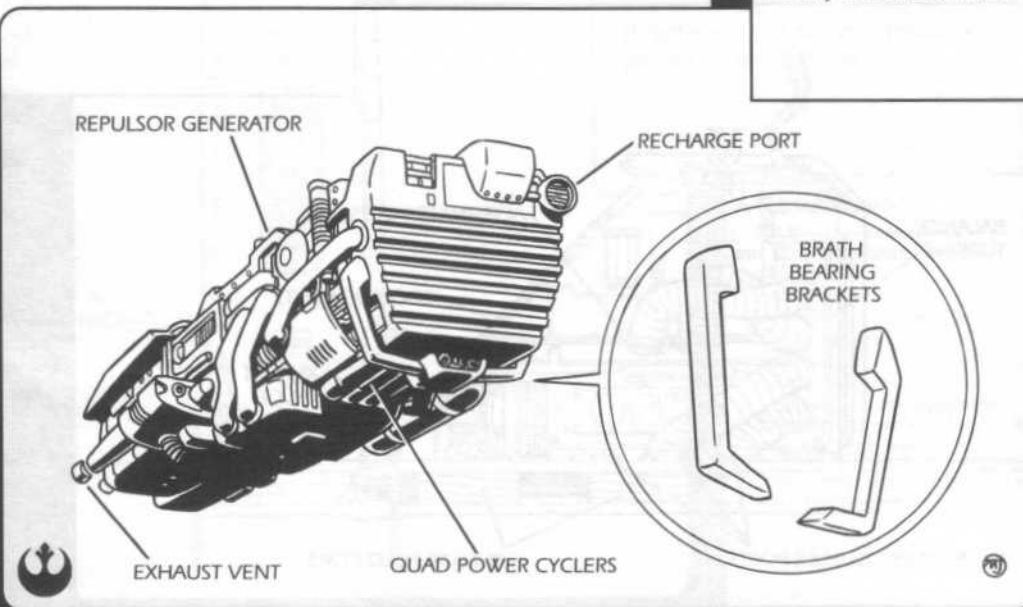

■ ADDENDUM/PERSONAL ■ CRACKEN, AIREN/GENERAL..

A speeder bike is already a hard machine to control. I suggest this modification only for very capable pilots. This change is a calculated gamble, because the hydroclampers can force the brath bearings to snap at any time. Do this at your own risk.

On the other hand, if you need the maneuverability ...

Once, I needed to race into an Imperial fortress to destroy its power generator so our troops could attack and steal supplies. Unfortunately, the area in front of the entrance to the fortress was full of repulsormines. The only way I could avoid the mines and avoid the blaster

fire from the stormtroopers in the fort was to alter a speeder bike. There was no time for solid shop work, so I just squeezed up the brackets and took off.

To this day I don't know exactly how I got by the mines, but I did it. The bike got me into the fort, although the steering crashed once I was inside. I slammed the throttle, jumped off, and heard the explosion of the speeder crashing into the generator as I rolled across the ground. Seconds later my troops moved in, capturing dozens of disoriented soldiers and a lot of valuable weaponry.

ENHANCED SPEEDER BIKE POWER DISPERSERS

ARATECH "POWER-SPREAD" — MODEL C285
POWER DISPERSION UNIT

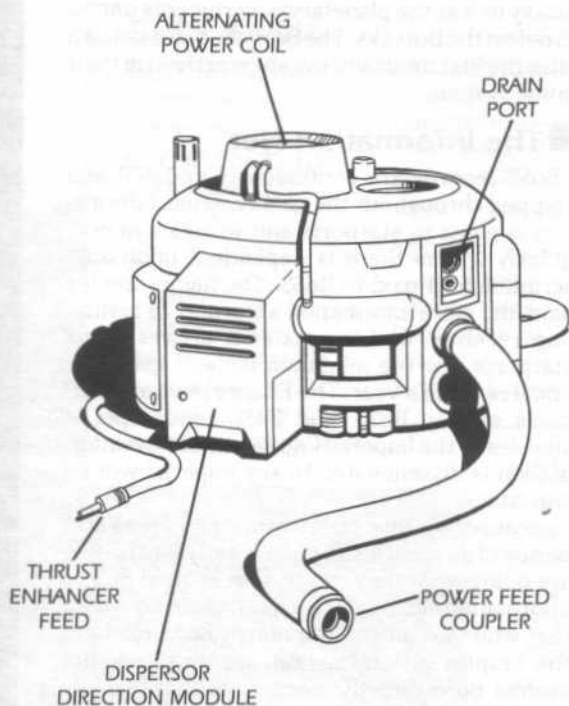

One way to get more speed out of a speeder bike is to replace the power dispersion unit in the bike with a dispersion unit taken from a smaller repulsorlift craft, such as an Imperial Sky Swooper.

The smaller unit will allow more power to flow from the generator to the engine, although there will be occasional power surges. The unit might also burn out entirely giving the engine a completely unregulated power flow. Needless to say, that could be disastrous.

After securing the smaller unit, attach a pair of silver foils between the unit and the engine. Despite what an engineer might tell you, the foils actually help the engine adjust to the increased power flow.

■ Specifications

Function: Increases Speeder Bike Speed Code

Components:
Small Power Dispersion Unit
Two Silver Foils (From a Swoop)

Scale: Speeder

Skill Code:

Build: Technology

Use: Repulsorlift Operation

Building Difficulty: As per Jury-Rigging Rules

Cost:
Small Power Dispersion Unit: 300 Credits

Jury-Rig Type: Vehicle

Increases speeder bike speed code 1D, 2D, or 3D.

■ ADDENDUM/PERSONAL ■ CRACKEN, AIREN/GENERAL..

The power dispersion units are responsible for handling the extra energy created by the bike's sporadic power surges. The stock units keep a bike running smoothly by creating an even power pattern. Without the correct dispersers the power builds up, which trans-

lates into greater speed. However, if the energy isn't used up fast, the system is going to overload. This is one of the few instances where going slow will increase the chances that the system is going to overload, so my best advice is to use the energy while you can.



TRANSPONDER CODES

Every starship has a transponder code: a unique signal beamed out continuously to identify the ship for any curious passers by. The code includes the name of the ship, its type, who owns it, and any pertinent records or data about the ship.

Transponder codes have existed as long as there have been spacefaring societies. All ships that want to conduct legal trade of any sort must have them (any ship without one is in serious trouble as soon as it encounters an Imperial or system patrol craft). The code is the only way to track ships from system to system.

The transponder code is built into a ship's sublight engines. The code is created by giving slight variation to the frequency pattern of every ship's engine. The engine itself sets the basic pattern, while the smaller elements, or "background" code, are created by a transmission device that transmits the code whenever the engine is on. The device, known as a transponder director, is sealed into every engine, so it is very difficult to alter.

Ship builders are required to record the transponder code of every ship they produce. When the ship is purchased, the owner's name, the intended use of the ship, and other pertinent information is recorded within the transponder code. As the ship is bought and sold (or lost and won), its standard routes change, or its weapons are upgraded, these changes are noted alongside the records of the ship's transponder code at the Bureau of Ships and Services.

■ BoSS

The Bureau of Ships and Services (BoSS) is one of the oldest institutions in the galaxy. It has its own customs, traditions, and unique personality. Most of the positions are filled through hereditary means. BoSS is as much a star spanning tribe as it is a civil bureaucracy.

As the decades have passed and one government after another has come into power, BoSS is one of the few bureaucracies to remain relatively unchanged. BoSS has assured itself independence for two reasons. First, the sprawling and complicated files of BoSS are kept in nearly indecipherable codes. Only family members have access to the organization codes of the files. The second reason is BoSS's long-standing policy of neutrality. Each power that rules or manages the galaxy simply inherits BoSS. Apparently, the BoSS family has no political aspirations, and the

Empire seems to be yet another government that accepts BoSS without threatening it.

Only once has BoSS faced a legitimate threat. Several centuries ago, the Borvak Clan threatened violence against the family. BoSS managed to bring interstellar trade to a standstill by threatening to delete every file of every starship in the galaxy unless the planetary governments united to defeat the Borvaks. The Borvaks backed down after the first thousand warships arrived in their home system.

■ The Information Net

BoSS records are continuously updated and shipped throughout the galaxy. What information is given to starports and worlds and how quickly it gets there is dependent upon subscription fees paid to BoSS. The higher the fee paid, the more information a starport or institution receives, and the faster it arrives. Most starports pay the minimum fee and get basic updates twice a year. The Empire pays an enormous sum to BoSS, and BoSS sends special shuttles to the Imperial Capital, where the information is disseminated to key Imperial worlds and bases.

Because we live in an especially "delicate" period of political history, more and more people are doing what they can to skirt around BoSS's information net. I want to make it clear, however, that while we must often outwit BoSS to cheat the Empire of information, we must not act against BoSS directly. Remember that the Alliance also buys information from BoSS.

BoSS sets up special units to track down people and ships who are attempting to circumvent their data gathering services. These operatives see the collection of this information as their duty to their subscribers and only use force defensively.

The BoSS operatives, known as Gatherers, do not have a uniform. And just as the BoSS tribe itself contains countless races from many different backgrounds, so to do the Gatherers defy a simple description. They are usually well trained in computer skills, espionage, and have a wide breadth of knowledge. Some are also trained as fighters.

Transponder codes can be listed as "classified" within the BoSS files. This means that the code is not available to standard subscribers. Being listed as classified costs several hundred thousand credits. However, BoSS also sells clas-

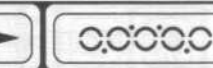



TRANSPONDER CODES/TEXTFILE/CONTINUED ■ CRACKEN, AIREN/GENERAL..

sified information for a higher fee. Although the Empire has enough credits to traffic such information, we've bought our fair share of expensive information from BoSS as well.

BoSS Agent

DEXTERITY: 3D

Blaster: 4D+2

Dodge: 3D+2

KNOWLEDGE: 4D

Alien Races: 5D

Cultures: 4D+2

Languages: 4D+1

Planetary

Systems: 4D+1

Streetwise: 5D

MECHANICAL: 2D

Beast Riding: 3D

Repulsorlift Op.: 3D+1

Starship Piloting: 3D+1

PERCEPTION: 4D

Con: 4D+2

Gambling: 4D+1

Hide/Sneak: 5D

Search: 4D+2

STRENGTH: 3D

TECHNICAL: 3D

Comp. Prog./

Repair: 4D+1

Demolition: 3D+2

Security: 4D+2

Starship Repair: 5D

BoSS Enforcer

DEXTERITY: 4D

Blaster: 5D

Brawling Parry: 4D+2

Dodge: 4D+1

Grenade: 4D+1

KNOWLEDGE: 2D

Survival: 3D+1

MECHANICAL: 3D

Beast Riding: 3D+1

Starship Piloting: 3D+1

Starship

Gunnery: 3D+2

PERCEPTION: 3D

Hide/Sneak: 3D+1

STRENGTH: 4D

Brawling: 4D+1

Climbing/

Jumping: 4D+2

Stamina: 5D

TECHNICAL: 2D

Security: 4D

Starship Repair: 2D+2

BoSS Bureaucrat

DEXTERITY: 2D

KNOWLEDGE: 4D

Alien Races: 5D

Cultures: 5D

Languages: 4D+1

Planetary Systems: 5D

MECHANICAL: 2D

PERCEPTION: 4D

Bargain: 4D+2

Command: 4D+1

STRENGTH: 2D

TECHNICAL: 4D

Comp. Prog./

Repair: 5D

Security: 5D+1

Starship Repair: 5D+2



ADDING TRANSPONDER CODES

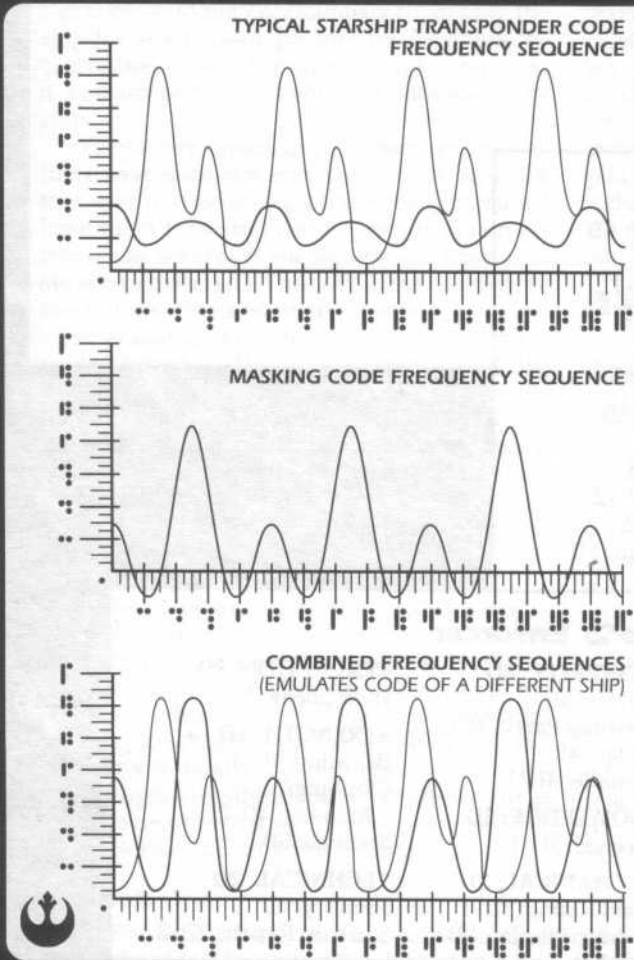

It is possible to add transponder codes to your ship to disguise its identity. You can have any number of false codes, but no more than three are suggested. If you have more than three, the codes begin to "bleed" and look suspicious.

To build a false code, you must first do an analysis of your ship's code. Then run the analysis through the program in file V844a of this datafile to find ships with similar codes. The analysis will produce several possible choices for signals to be added to your standard signal. By adding these signals to your base code, you'll create a different pattern. This pattern can be built into a standard sensor-transponder box refitted according to Alliance Akr43 specs. Attach it to your sublight engine and you're all set.

Specifications

Function: Adding False Transponder Codes

For a starfighter scale ship, the first false transponder code costs three skill points, 1,500 credits and requires an *Easy technology* roll. The second code costs six skill points, 3,000 credits and requires a *Moderate technology* roll. The third code costs nine skill points, 4,500 credits and requires a *Difficult technology* roll. Fourth and subsequent codes costs 12 skill points, 6,000 credits and require a *Very Difficult technology* roll.

After more than three false codes have been added, anyone scanning your ship who makes an *Easy technical* roll will realize that there are several codes bleeding into each other. It takes one week to add a false transponder code to a starfighter scale ship.

ADDENDUM/PERSONAL ■ CRACKEN, AIREN/GENERAL..

When you run the program in V844a, it will give you a list of signals you can add to your ship's signal. Then, you must go through the log of transponder codes of active ships close, if not identical, in design to yours. A ship's transponder code should pull an A-3 match or better against your new transponder code. Another requirement is that the ship not travel very often in the

area you travel. This is a very boring, time-consuming task, and will take about a week of checking until you find a useable code to mimic.

Once you've found such a code, this is the one you should put into the sensor transponder box.

When you switch on the box, someone checking out your ship's code will believe it is the other ship.



REMOVING A SHIP'S TRANSPONDER CODE

A transponder code is burned into the sublight engine of every starship. It is very difficult to remove a code, for the base pattern is emitted from the engine itself, and if the "background code" emitter is altered, it fuses the wiring of the sublight engine, rendering it irreparable. There is the alternative of overloading the signal so it cannot be read as a unique code.

To do this, set the engine's cobulators back a half pitch. Then patch the third scad line into the power supply, first running it through a plasma displacer. This will send out an external energy surge, but will leave the proper calibrations for the engine intact. Your engine will run hot only near the transponder, while the rest of the unit runs with no problems. There is only a marginal drop in power. As for the transponder code, the energy surge will create so many overlapping waves that a proper reading of your ship's code will be impossible.

■ Specifications

Function: Removing a ship's transponder code

Components:

Plasma Displacer

Skill Code:

Build: Technology

Building Difficulty:

To Blur Signal, Moderate.

To Restore Signal, Difficult

Cost:

Plasma Displacer: 300

Availability: R

The procedure is reversible.
It takes four hours of work to blur the signal. A full day's work is necessary to restore the signal.

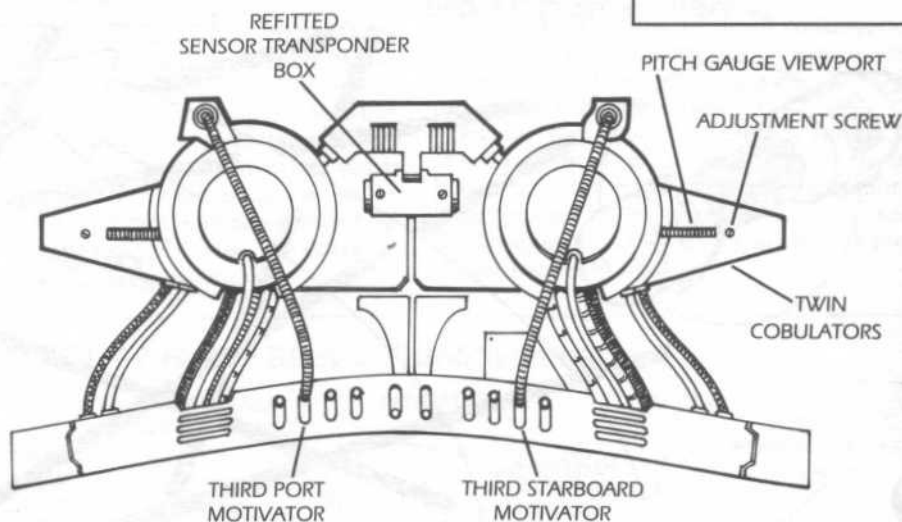

■ ADDENDUM/PERSONAL ■ CRACKEN, AIREN/GENERAL..

The distortion takes some distance to build up. A starship trying to get a reading on you while next to you will get a distorted code, but their computer will probably be able to clean the signal up and identify you. However, at a distance your ship will be unidentifiable because the engine is giving out an extra signal, distorting the original signal.

Remember that you are still giving off a signal. There's no way to avoid the fact that your engines will release

energy and give off a pattern. Thus, when someone picks you up on their sensors they will know that you have obliterated your transponder code! For the most part, local authorities find this reason enough for investigation, and usually arrest and imprisonment. It is as if you are putting a mask on your ship. Everyone can see you, but they don't know who you are.



■ DATA SEARCH ■ PROG40046 ■ FILEPATH 9011/29P//EOP.ADB//SC ■ FILEFORM..D.PAD/DOWNLOAD
■ SOURCEFILE: CRACKEN'S REBEL FIELD GUIDE ■ SECTION SIX: VEHICLES ■ DESIGNATION..



IMPERIAL XX-23 S-THREAD TRACKER

The star-spanning technology of the Holo-Net allows the Empire to operate a tracking device that can trail a ship throughout the galaxy. The Imperial tracking device uses a scaled down version of a Holo-Net transmitter, which broadcasts a signal that can be picked up by the Net's hyperspace S-threads.

Imperial computers continuously compute the signal's direction and distance, telling the Empire what section of the galaxy a ship is headed for or what system it has docked in. The relay of information is instantaneous. The computers track the ship's general direction while in hyperspace. Once the ship drops into normal space, it can be tracked to within one parsec. The tracking device normally signals a specific outpost or Imperial officer.

■ Specifications

Item: Imperial XX-23 S-Thread Tracker

Type: Hyperspace Ship Tracker

Skill Code:

Tracking: Astrogation

Difficulty: Difficult

Range: Unlimited

Imperials may make one *astrogation* roll per hour to track ship. In hyperspace, only the general direction of the ship may be found. Once in normal space, the ship may be tracked to within one parsec.

Tracker is too powerful at ultra-high frequencies to find exact location, and system in question must be searched with conventional means.

Tracker is a 10 cm long tube. May be easily destroyed if found.

In no way interferes with normal communications or cannot be detected by such means.

*: CODED TRANSMISSION POINTS
(WHERE SHIP INTERSECTS S-THREAD)

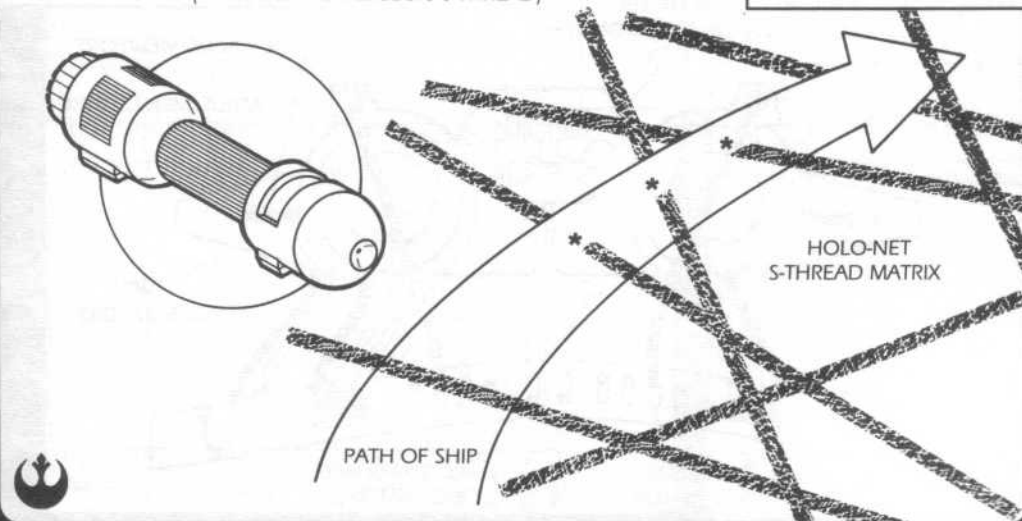

■ ADDENDUM/PERSONAL ■ CRACKEN, AIREN/GENERAL..

The trouble with these trackers is that the Rebellion doesn't control the Holo-Net technology. There is no way for the Alliance to scan for S-thread signals and see if we are being tracked; to see if a ship is bugged, you've got to search the whole thing.

Fortunately, the devices are too expensive for the Empire to use them more than sparingly. Since most of the Net has been dismantled (except for strategic military transceivers), the odds are good that a bugged ship won't cross enough S-threads to allow for accurate tracking until the ship drops into normal space.

The only time I've ever used an Imperial tracking device to my advantage was when I'd found one aboard

my ship and planted it on cargo that was going to be transferred to an Imperial Star Galleon. We not only got the Imperials off our tail, but sent them after one of their own ships.

By the way, we've all heard of how Skywalker and his companions were allowed to escape from the first Death Star so that they might lead the Empire to the Rebel base. I've heard some of the younger recruits discount the tale, asking why would the Empire waste four TIE fighters if they were planning to let the Falcon go anyway. They don't understand. The Empire is always willing to waste good men and equipment if it thinks the sacrifice will serve larger goals.

PREVIOUS

DATAPAGE: 62

NEXT



HOW BLASTERS WORK

Blasters have long been the dominant form of weaponry in our galaxy. While blaster technology is continually advanced and refined, the basic function of the weapon remains unchanged from the first primitive weapons. The BlasTech DL-44 Heavy Blaster Pistol is currently one of the more popular personal weapons. The function of the DL-44's internal components is repeated in every blaster, from the simplest hold-out blaster up to the massive turbolasers on Imperial Star Destroyers.

Operation

Every blaster carries a small supply of excitable gasses which are held in the Gas Chamber. Different gasses provide different power levels and different colored bolts. On the DL-44, pulling the trigger opens the Heter-Valve energy converter valve. A small amount of gas flows into the XCiter gas conversion enabler and is excited by the energy released from the power pack. The excited gasses are moved to the Actuating Blaster Module and then released as a beam of intense energy and light. The energy from the released gas is focused, or galvenned, when it passes down the barrel of the gun. The light is an unimportant by-product of the operation because the energy is what gives a blaster bolt its punch.

Blasters can take a lot of hard falls, their power packs are easy to recharge or replace, and they are easy to use. The only real problem for blasters is acquiring adequate amounts of blaster gas. Although a very small amount of gas goes a long way, eventually it runs out.

Most Rebel field groups carry a large canister of gas with them to replenish gas supplies for their blasters. When I say large, I recommend nothing bigger than the size of a canteen. If you need more gas for an extended operation, bring several containers. Merr-Sonn has a fine gas container that can keep six active Rebels supplied with excitable gasses for two weeks.

In a pinch, I've taken the lubricant container of a demolished Droid and used it as a gas canister. Make sure to rinse it with some Berko-8 first. You'll need a to change the valve nozzle for M820, M835, and 976a lubricant containers, but the nozzles of other containers I've encountered fit snugly onto the blaster's gas chamber nozzle for a proper transfer of gasses.

Orveth, sig, prothium, eleton, tolium, and skevon are the six most common gasses used for blasters, and normally cost 50 credits for per large canister. Other gasses, such as spin-sealed Tibanna gas from Cloud City, are just as powerful but harder to find.

Blastech DL-44 Heavy Blaster Pistol/Schematic

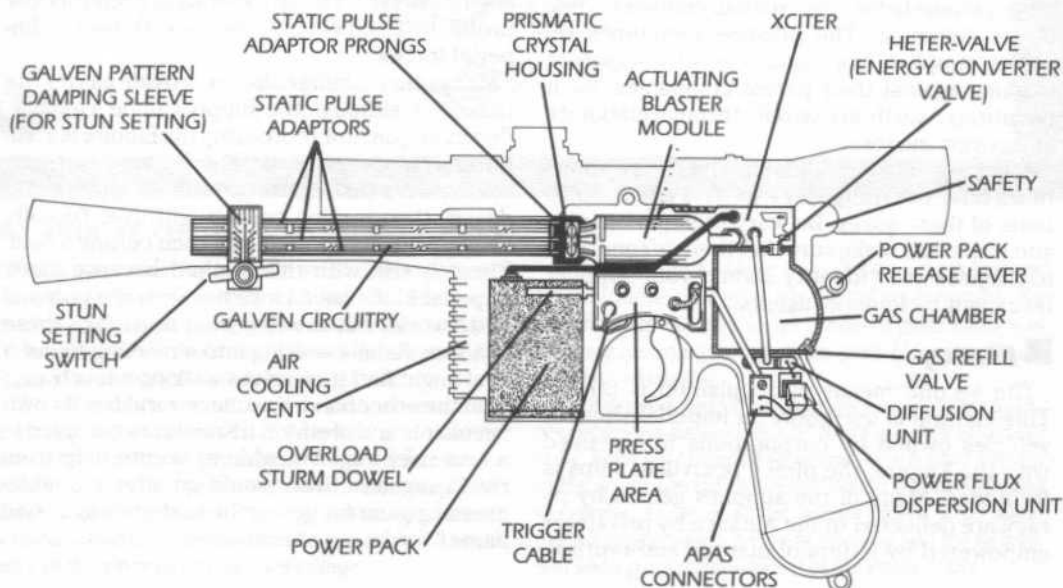

BLASTER BEAM SPLITTER

To increase the spread of blaster fire you'll need to alter the galven pattern and get three beam gems, either size 4 or 5, like the ones used in the optical tracks of the Merahassa Bansa Nav Computer series.

To alter the galven pattern, remove the barrel of the gun and input the code sequence from file 37L0b into the circuitry.

Then insert the gems as pictured here. The tricky part is getting the three beam gems in the barrel of the blaster to *stay*. I've found that a mixture of Bantha sweat and any major pohl adhesive works best. Don't ask me why.

When the blaster is fired, the beam is diffused slightly. This gives a wider arc of fire, but reduces the impact of the beam when it hits.

■ Specifications

Item: Blaster Beam Splitter

Components:

Three Beam Gems

Adhesive

Scale: Character

Skill Code:

Build: Technology

Use: Blaster

Building Difficulty: Very Easy

Jury-Rig Type: Lethal

Increases character's *blaster* skill 1D.
Decreases weapon damage 1D.

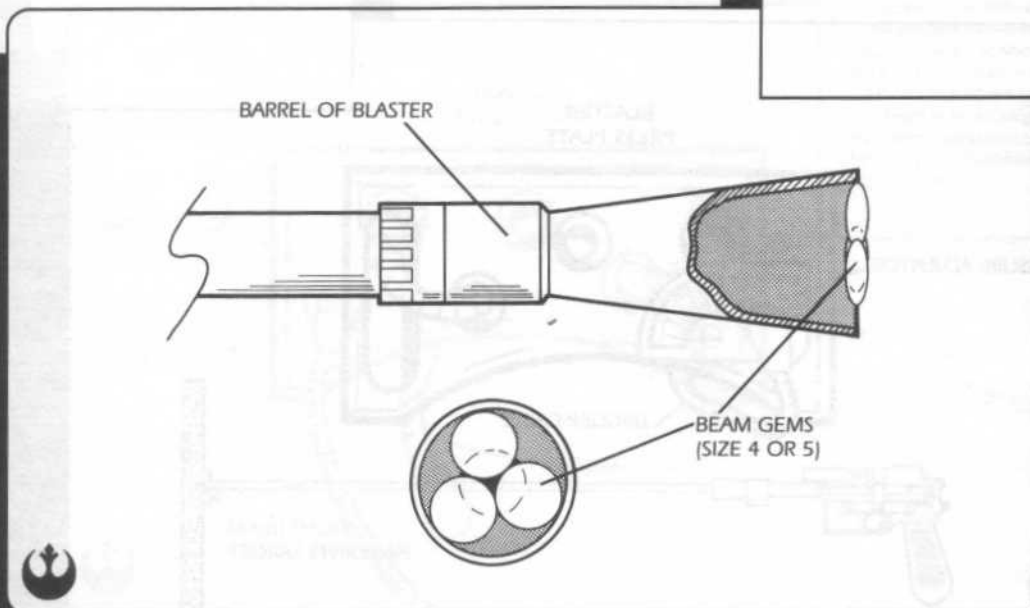

■ ADDENDUM/PERSONAL ■ CRACKEN, AIREN/GENERAL..

The gems are hard to come by, so I'd only use them if you salvaged them from from a broken nav system and don't need them as backups. This modification is especially effective if you're only trying to impress the opposition without seriously harming them.

This tactic came in handy when we made an assault on a farming village on Carnth. The Imperial prefect of the world had made many promises of reward if the farmers remained loyal to the Empire. He'd made the Rebel Alliance out to be a pack of smug pirates. The farmers refused to talk to us, but we needed to establish a small base in the strategically located village.

HQ decided that I'd lead a small team into the village for one more shot at a negotiated compromise. We modified our blasters so we'd have a good chance of stunning as many of them as possible without any needless casualties.

Upon approaching the village, we were charged by the poorly armed farmers. We let loose a volley of blaster bolts. Each shot stopped someone, which gave the rest of the group second thoughts. I called a cease-fire and demanded to speak to the village elders. After some intense negotiations, we were allowed into the village, and soon gained the support of the entire town.

BLASTER SIGHT

The way I get a blaster to sight is to reset the trigger to release a very small amount of gas into the XCiter with a half squeeze. This gas is excited as normal, but there is only enough energy to produce light, which is focused by the barrel. When the beam of light shines through the barrel, it can be used to pinpoint exactly where shots will hit.

To adjust the blaster, unplug the trigger cable from the press plate area. Plug a variable pressure adjustor (from any pocket computer keypad) into the impulse slot, and set it for between 0.106 and 1.0. Then plug the trigger cable into the pressure adjustor.

Specifications

Function: Blaster Sight

Components:

Variable Pressure Adjustor (from a pocket computer keypad)

Scale: Character

Skill Code:

Build: Technology

Use: Blaster

Building Difficulty: Moderate

Jury-Rig Type: Lethal

Adds 1D to character's *blaster* skill.

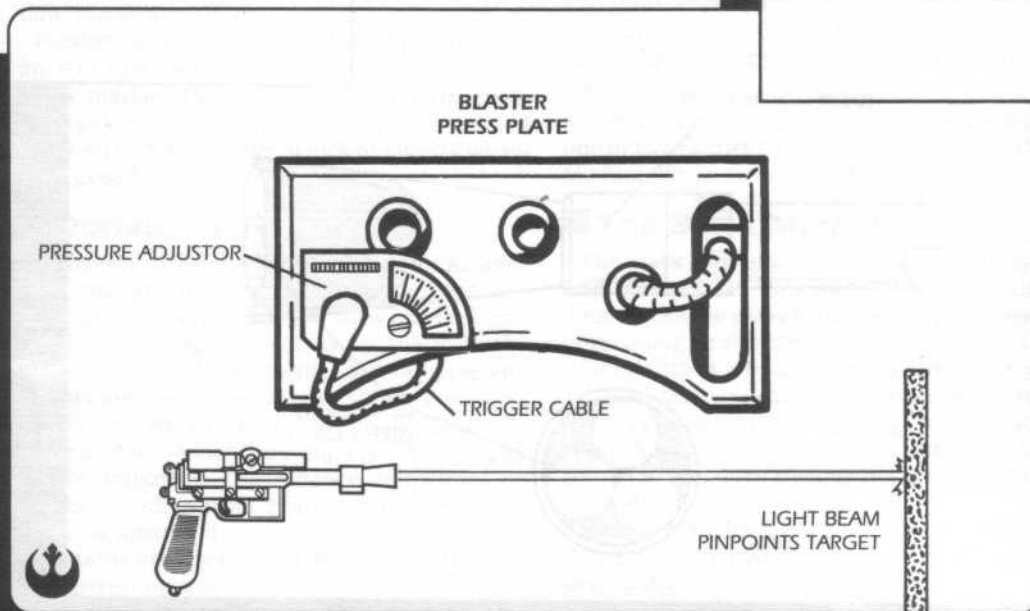

ADDENDUM/PERSONAL ■ CRACKEN, AIREN/GENERAL..

There are a variety of blaster scopes out on the market which are more stable and dependable. However, in the middle of a fire fight I don't have time to take a look down the length of my blaster. The beauty of this modification is that your blaster marks the target for you.

There are devices that will let you get the same effect as my modification. Usually they're mounted on the side

of your blaster and shine a safe beam of light in a converging line along the length of your barrel. These devices are expensive, running from 500 credits to 1,000 credits, depending on the accuracy of the sight. Especially recommended are the True Site and Red-Eye from SoroSuub.

BLASTER TRAP

To create a blaster trap, you'll need a blaster and a trip. If you don't have a manufactured trip handy (see Pressure Plate, Heat Sensor, and Motion Sensor entries in this datafile), you can make a quick trip wire from cable and tie it to the trigger of a firmly placed blaster. The blaster fires when the string is pulled by an unsuspecting target's foot.

If you've got a manufactured trip handy, take off the blaster's left press plate, remove the trigger cable from the impulse slot and plug in the plate or the sensor. Blasters all have a V-4 plug, so make sure that's what you new trip has, or have an adaptor handy.

Specifications

Item: Blaster Trap

Components:

Blaster

Scale: Character, Walker or Speeder

Skill Code:

Build: Technology

Building Difficulty: Very Easy

Jury-Rig Type: Special

The trap's *blaster* skill die code depends on how well the trap was set. If the *technology* roll gets a Very Easy success, the blaster gets 1D; Easy gives 2D; Moderate gives 3D; Difficult gives 4D; Very Difficult gives 5D.

Increase the difficulty of the blaster to hit a target by one range. Thus, if the trip cable is set at Short range, the gun fires at Medium difficulty.

Once a trip wire has been triggered, the blaster is dislodged or the cable has been pulled loose. If using a manufactured trip, the blaster will remain in place indefinitely.

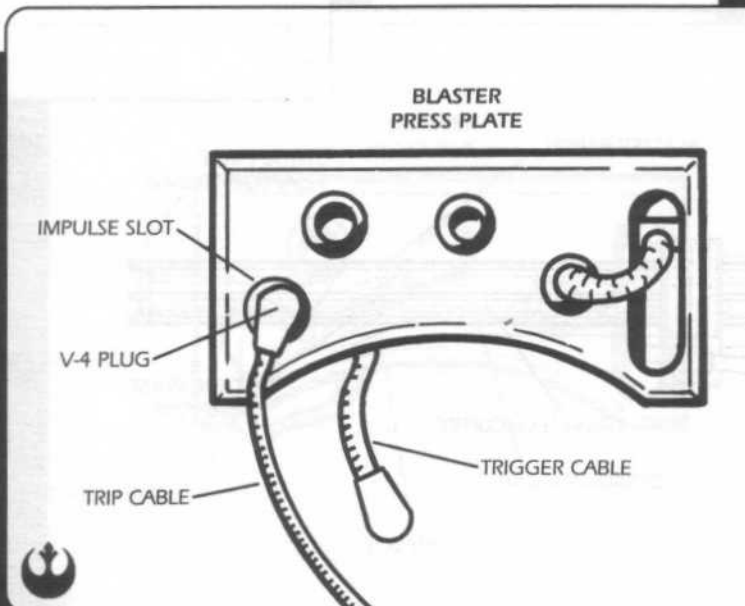

ADDENDUM/PERSONAL ■ CRACKEN, AIREN/GENERAL..

When setting a blaster, make sure that it is secure. I once set a pistol with a wire trip and a stormtrooper ripped the gun out of the crevice I'd shoved it into. If possible, set your blaster traps with several guns all triggered off the same trip. This gives you a better chance of hitting the target.

As with all mechanical deceptions, you want to build your trap in an environment with many visual distractions. Suitable environments are swamps or jungles, or even rough edged caves. You want the situation to be busy and the opposition moving so quickly there isn't time to notice the traps.



UPGRADED BLASTER GALVEN PATTERN

The galven pattern in any blaster's barrel can be altered to increase the damage value of the weapon. The galven pattern is formed by a static-pulse field that is created by micro-electronics built into the barrel of the gun. To increase the power of the pattern, remove the barrel from the rifle. At the end of the barrel, you'll find three static-pulse adaptors that are linked to the XCiter. Tie these prongs into a computer system or a Droid and program in the code sequence listed in file 8A70b of this datafile.

You'll find that using VT-7 as your language will make the transfer easier. Most blasters can't handle the new power levels and eventually break down, but until that time they are very lethal.

Specifications

Function: Upgraded Blaster Galven Pattern

Components:

Blaster
Droid or Datapad

Scale: Any

Skill Code:

Build: Technology
Use: Blaster, Heavy Weapons or Starship Gunnery

Building Difficulty: As per Jury-Rigging Rules

Damage: 1D, 2D or 3D Upgrade

Jury-Rig Type: Lethal

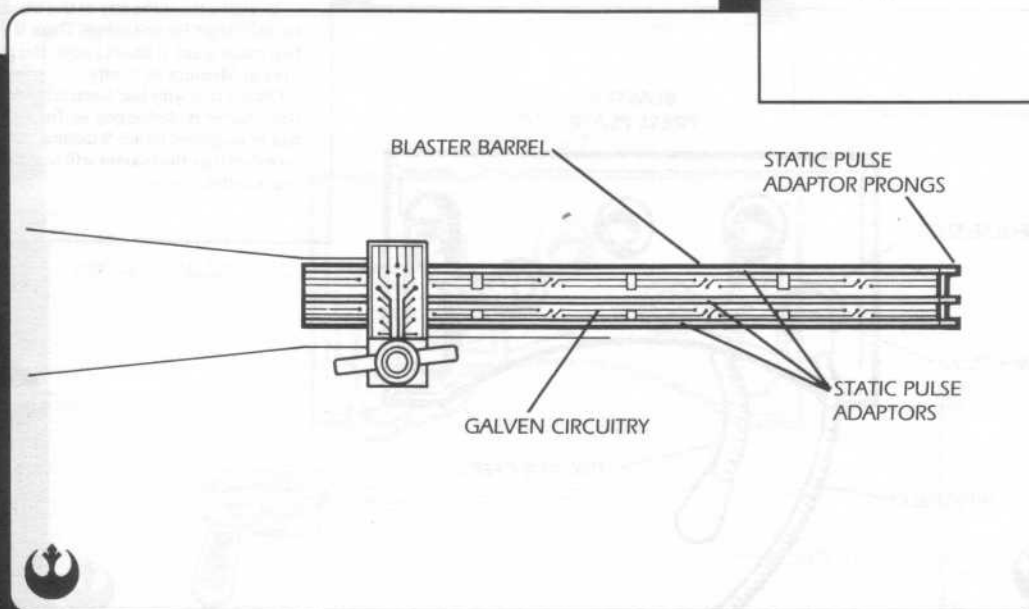

ADDENDUM/PERSONAL ■ CRACKEN, AIREN/GENERAL..

A friend of mine, Inat Rangoon, got this code sequence from BlasTech a few years ago. He knew they were up to something in the weapons research department. He forged himself an ID and introduced himself as an off-world investor. They believed his cover and gave him a tour of the plant.

Meanwhile, the rest of his group, after slicing their way through the research facility's security devices, cut the plant's power. The emergency systems kicked in, alerts were called and Rangoon was politely shoved into a conference office until the area settled down.

Rangoon pulled up the conference room's computer system and found the file he'd heard about. Since

everyone thought the threat was a physical assault from outside, he had time to load the data into his vessel implants. He finished pulling the data just before they came back to get him and reassure him that the facility was safe. Rangoon calmly finished the rest of his tour.

When he examined the data, he learned that his hunch was correct. However, the process used to build the improved blaster was dangerous. The strengthened patterns created a "ripple-wash." The strong pattern of the energy jostled the gun's barrel, sometimes shattering it. However, the temporary benefit can be useful in a tight situation. The BlasTech A280 is the first application of the technology on the market.

BLASTER HAIR TRIGGER

A blaster's energy converter valve can be adjusted to open and shut twice on a single trigger pull. To jury-rig your blaster to do this, you'll need to run a scomp link (or any of the mini-cables in the Tarris 800 line) from the trigger adaptor to the gun's impulse slot. Once the mini-cable is in place, adjust the frequency rate of the Impulse Slot (V-4) from 42 z to 83 z. This will set up a feedback loop between the trigger and the Impulse Slot (V-4). When you pull the trigger, the valve will open as usual, but as soon as it does, another impulse will be routed through the mini-cable and tell the valve to open again.

Specifications

Function: Blaster Hair Trigger

Components:

Scomp Link (from Comlink)

Scale: Character

Skill Code:

Build: Technology

Use: Blaster

Building Difficulty: Difficult

Cost:

Scomp Link: 10 Credits

Jury-Rig Type: Lethal

A hair trigger lets the Rebel get two rolls to hit for each shot taken. If the Rebel shoots twice, he loses one die off all shots, but gets to make four rolls to hit.

Each "bonus" shot (the second shot from one trigger pull) counts toward the jury-rig failure. If any of the damage dice come up as a one, the game-master rolls on the breakdown table.

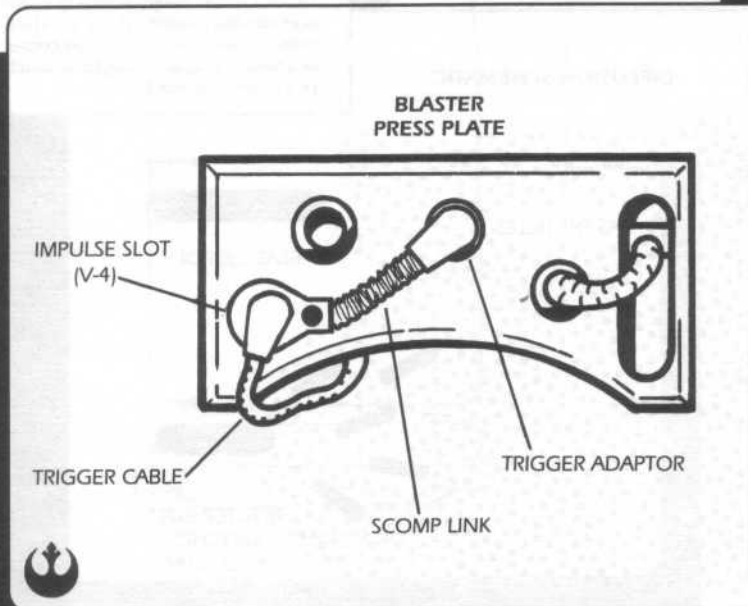

ADDENDUM/PERSONAL ■ CRACKEN, AIREN/GENERAL..

I taught this trick to a group of younger Rebels once and it turned into a disaster. Our objective was to break out of a cell block in an Imperial Garrison base. A Rebel agent, posing as a guard, had smuggled blaster parts to our cells. As we were putting them together, I showed the lads how to modify the guns for hair trigger firing. Since we were about to confront a great many stormtroopers, the shots would be a good way to provide cover fire. We didn't need to be accurate or to stand and fight — after all, we just wanted to clear a path for ourselves.

When we made our break, all the men around me seemed determined to take out as many stormtroopers as possible — as if we were actually going to make a dent in the Emperor's legions that day! Although I'd given explicit orders that flight, not combat, was called for, they abused the advantage the hair trigger blasters gave them. They fired so many times that most of the blasters broke within seconds. Most of us escaped and returned to the agent's shuttle, but too many were victim to a mistaken sense of superiority.



BLASTER BOLT DIFFUSION

One standard-sized canister of *gaseous* engine coolant can be used to create a diffusion field for blaster fire. The coolant must be pressurized and contain 40% courenth and at least 3% ves. For effective dispersion, I usually slip a V30 or higher landspeeder mixture filter over the canister's valve. The filter lets out a thick, even spray centered around the canister. Blaster bolts entering the mist are dispersed and lose their effectiveness.

Note that unless you're inside a really thick cloud of the stuff, visibility is not severely hampered. You can see out of the mist, and your opposition can see into the mist. The mist will remain effective for about two minutes.

Specifications

Function: Blaster Bolt Diffusion

Components:

One-liter canister of gaseous Engine Coolant
V30 Landspeeder mixture filter

Scale: Character

Range: 1 Meter

Damage: Reduces Blaster Damage by 1D

Ammo: 1 Per Liter

Availability: 1

Cost:

Coolant: 50 Credits Per Liter
Mixture Filter: 25 Credits

One liter of coolant will form a three by three meter cloud for 12 rounds. If the area is windy, the cloud will disperse in half the time.

All blaster bolts entering the cloud lose 1D of damage.

Each liter of coolant comes in a canister one-third meter tall, by one-third meter in diameter. The canister comes as a sealed unit, so it weighs as much as a heavy backpack.

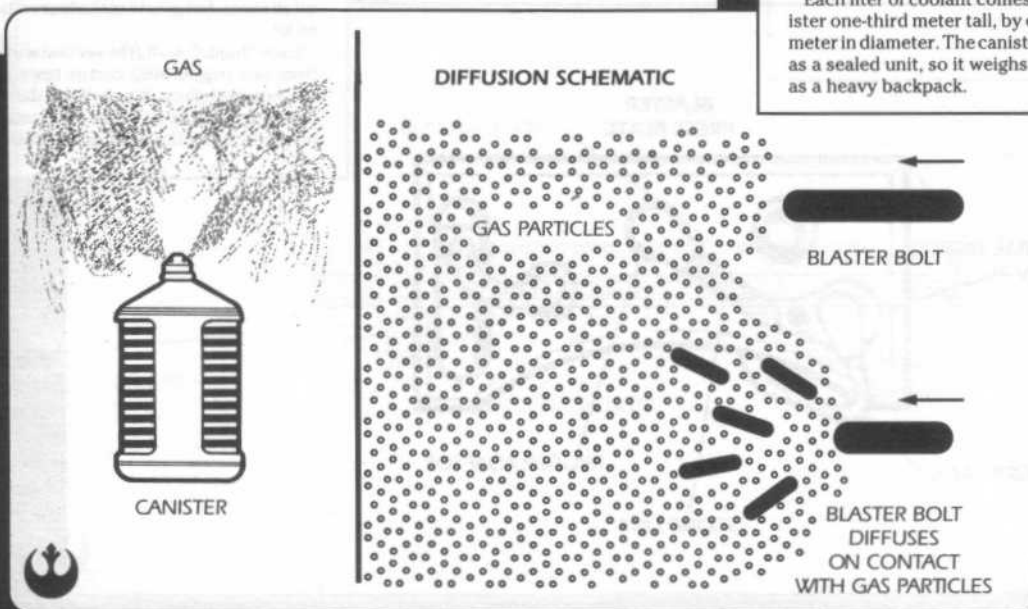

■ ADDENDUM/PERSONAL ■ CRACKEN, AIREN/GENERAL..

There are two things to remember about using the gas for this purpose. First, the stuff doesn't block your line of sight, so you can fire out of it as if you were hiding behind a wall. And if you're going to use it, remember that it's a stationary shelter. You can't run with a canister spraying out mist, and expect the mist to keep up with you. When you release the gas, it fills the immediate area. Stay behind the thick wall of the stuff if you expect

the gas to do any good. Obviously, this isn't the most practical way to protect yourself from blaster fire.

Second, the canisters are designed to keep the gas safe, not provide easy movement. Running around with these things is tough — they're not that heavy, but they're bulky and get in the way. The three times I used them, we had them planted ahead of time and dug them up as we went.

EXPLOSIVE SLUGS

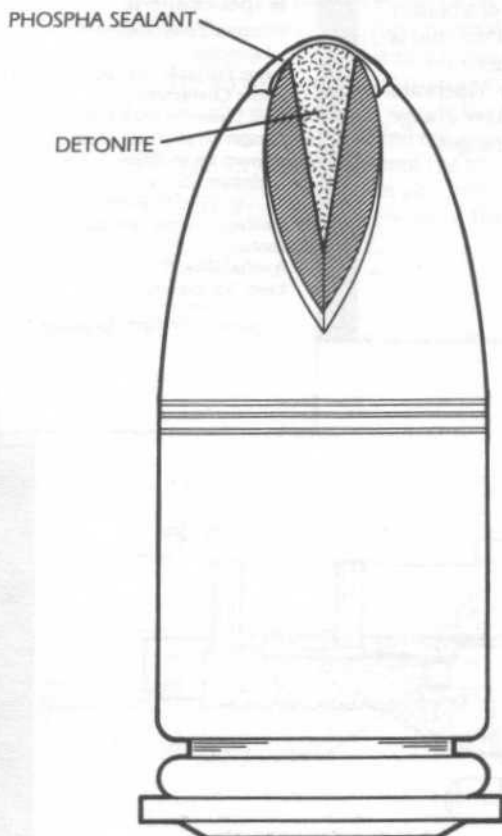

STANDARD SLUG

These aren't manufactured explosive slugs, but improvised shells used specifically against stormtrooper armor. Hollow out the tip of an average slug with a three-to-one ratio inverted cone and pack the tip with detonite. Seal the tip with sealant mixed with phospho, a substance that ignites on impact (two parts sealant, one part phospho).

Fire the slugs normally. When the shells hit the hard armor of the stormtroopers, the phospho ignites and sets off the detonite. The explosion renders the stormtrooper's armor useless.

The explosive slugs do no extra damage against "soft" targets because the phospho does not ignite.

Specifications

Item: Explosive Slugs

Components:

Normal Slugs
Three-to-one ration inverted cone
(from Vehicle Tool Kit)
Detonite
Phospho

Scale: Character

Damage: +1D damage against any hard armor

Cost:

Detonite: 50 (enough for 10 slugs)
Phospho: 25

Availability:

Detonite: F
Phospho: I

The slugs work on any hard armor, although they were designed for stormtrooper armor. On hard armor, add 1D to damage. Without hard armor, calculate damage normally.

One hour to prepare 25 slugs.

ADDENDUM/PERSONAL ■ CRACKEN, AIREN/GENERAL..

I developed the explosive slugs on Vatta Four, when I found myself without my blaster (it had destroyed itself after I jury-rigged it with a hair trigger). All I could get my hands was a locally made slug thrower rifle (a Baed

Sharpshooter, I think it was called). I took some detonite I had from a charge and prepared the explosive shells myself.

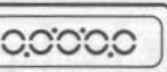

ZONE CONTROL VIPER GRENADE LAUNCHER

The Viper grenade launcher is mounted under the barrel of a blaster rifle or carbine. The launcher can carry two grenades at a time, and is fired by depressing a button on the right side of the launcher.

Built with vibro balancing systems and a Tybrene launcher, Vipers are considered the best gun mounted grenade launchers. They have a range of up to 500 meters and are extremely accurate at shorter ranges.

■ Specifications

Weapon: Zone Control Viper Grenade Launcher

Type: Portable Grenade Launcher

Scale: Character

Skill Code: Heavy Weapon

Range:

Short: 1m to 250m

Medium: 251m to 350m

Long: 351m to 500m

Damage: As Per Grenade.

Ammo: 5

Availability: R

Cost: 500 credits

Takes two rounds to reload.

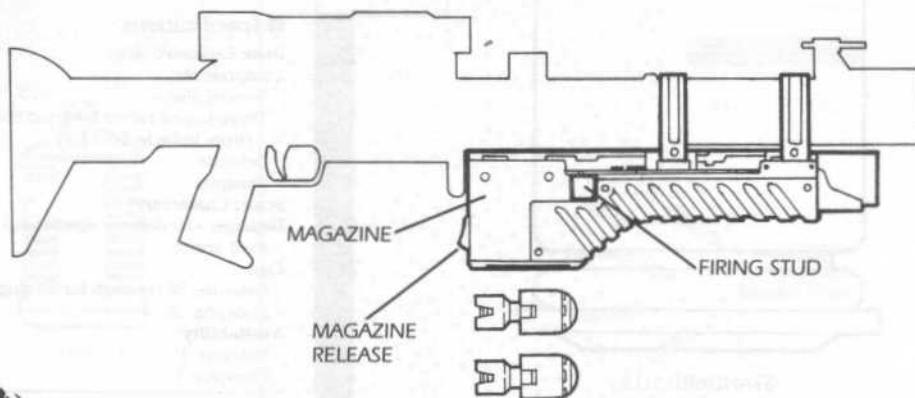

■ ADDENDUM/PERSONAL ■ CRACKEN, AIREN/GENERAL..

The Viper is a good friend of mine. Often these grenade launchers softened up stormtrooper defense points before I had to rush them with my blaster. The only problem with the Viper is its limited ammo capacity.

Several times I've been caught off guard by approaching stormtroopers while I was frantically trying to get fresh grenades into the launcher.

JAWA IONIZATION GUN

Although not well known in the galaxy, the Jawa ionization gun is a clever piece of work. To make the gun, the Jawas gut any handy blaster rifle and replace the laser components with a special ion accelerator of their own design. The accelerator is made from a Droid restraining bolt wired to an accu-accelerator, typically used in the ignition systems of capital class ships (I never was able to find out where the Jawas found the parts — they were very secretive about the whole matter).

The gun releases an intense ion beam and, with luck, the Droid is ionized. Because of the peculiar frequencies of the Droid restraining bolt, the guns cannot harm organic life.

Specifications

Item: Jawa Ionization Gun

Components:

Blaster rifle
Droid Restraining Bolt
Accu-accelerator (from Capital Starship ignition system)

Scale: Character

Skill Code:

Build: Technology
Use: Blaster

Building Difficulty: Moderate

Range:

Short: 3m to 4m
Medium: 5m to 8m
Long: 9m to 12m

Damage: 3D (affects Droids only)

Availability: Not available for sale

Jury-Rig Type: No-Dice/Lethal

Affects Droids only. Calculate damage for knockout purposes only. No permanent damage occurs.

User adds 1D to *blaster* skill.

The gun may be jury-rigged for extra damage (use the regular jury-rigging difficulties in the Introduction). Cannot be added when weapon is built.

Is a No-Dice jury-rig device unless extra dice of damage are added, at which time it is a Lethal device (for breakdown purposes).

BLASTER RIFLE STOCK
AND POWER ASSEMBLY

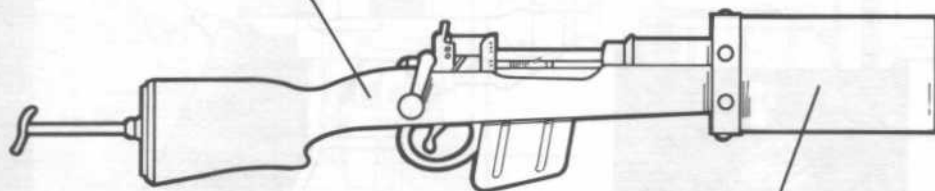

ION ACCELERATOR

ADDENDUM/PERSONAL ■ CRACKEN, AIREN/GENERAL..

This unusual weapon came in real handy once. The Empire had sent a half dozen assassin Droids after my group. Our supplies were low and we were outgunned. Trapped in an orbital shipyard, we broke into a supply warehouse and grabbed the ignition parts we needed, retooling our guns to deal with the Droids.

The showdown was a dangerous game of cat and mouse in the middle of the massive frame of an Imperial Star Destroyer. We led the Droids into one trap after another, but we knew we couldn't get them all. I lured the final Droid away from my companions in a desperate bid to let them escape.

As the Droid closed in, my gun exploded in a shower

of sparks. I fled to the construction platforms using my rocket pack. As I rounded a platform, I came face to face with a squad of vacc-suit clad security agents.

I cut the power and drifted right through the pack of men. A second later, the Droid whirled around the corner. He picked up the heat ahead of him (the security guards' rocket packs) and fired a concussion bomb. It took three guards down instantly.

The surprised guards returned fire on the Droid. In the confusion, I slipped into the platform's control pod and activated the magna-grapple. The huge magnetic plates hummed to life, trapping the Droid and the men flat against the floor.

MERR-SONN ANTI-RIOT TANGLE GUN 7

These weapons are from the early days of Palpatine's rise. The growing Empire needed weapons for crowd control that would be considered more "humane" than blaster fire. Merr-Sonn produced the Anti-Riot Tangle Gun 7.

The guns fire a large semi-plastic webbing made of synthetic naorstrachem linked with a shrinkage element. It is activated by contact with a warm surface.

The web wraps around the target and then tightens, trapping the individual. Sometimes the webbing tightens so much that the person suffocates, but this is rare.

A tangle gun round can only catch one target. Even if two targets are close to one another, the webbing will still contract on the first target it hits.

■ Specifications

Weapon: Merr-Sonn Anti-Riot Tangle Gun 7
Type: Crowd Control Defense Weapon
Scale: Character
Skill Code: Tangle Gun (new)
Range:
Short: 3m to 10m
Medium: 11m to 19m
Long: 20m to 25m
Damage: 4D
Ammo: 15
Availability: X
Cost: 300

The web holds with a *Strength* of 5D. Anyone getting twice the total of the web's *Strength* is free.

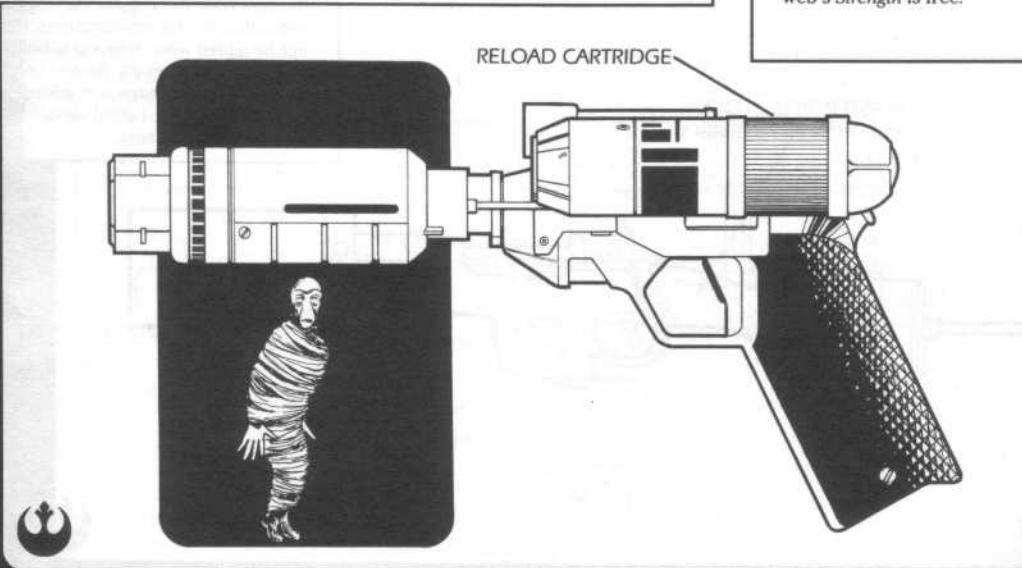

■ ADDENDUM/PERSONAL ■ CRACKEN, AIREN/GENERAL..

Tangle guns were mothballed some time back when Imperial policy moved from one of seduction to one of brute force. The fact that they were supposed to be non-lethal weapons does not mean that they cannot kill.

Despite efforts by Merr-Sonn, the tangle webs often contract too much, doing serious damage to the trapped person.

MICRONITE EXPLOSIVE CHARGE

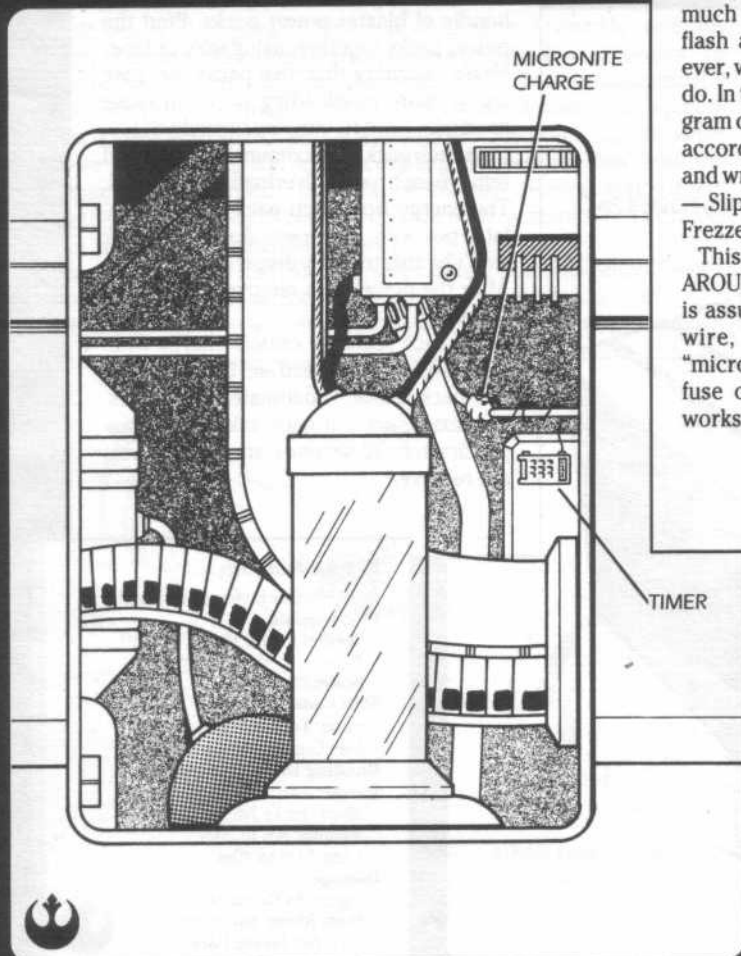

Most explosives are designed to do as much damage as possible with as much flash as possible. There are times, however, when a limited amount of damage will do. In these cases, take approximately one gram of detonite (the actual amount varies according to the specifics of the task at hand) and wrap it inside a piece of wadable metal — SlipSheet, or even a wrapper for Godon Freezes.

This wad of detonite should be wrapped AROUND the object you wish destroyed (it is assumed that the object is small, like a wire, or an electronic control). The "micronite" can then be detonated by a fuse or timer. BlasTech's Nano-Counter works wonderfully for this.

Specifications

Item: Micronite Explosive Charge

Components:

- 1 gram Detonite
- Piece of flexible metal

Skill Code:

Use: Demolition

Cost:

100 Grams Detonite: 50 Credits

Availability: F

No roll necessary to build.
Does no damage to characters.
Must be placed next to target device.
Ineffective on items larger than 10 cm by 10 cm.

ADDENDUM/PERSONAL ■ CRACKEN, AIREN/GENERAL..

"But, Sir!", I can hear the lot of you shouting, "Don't we want to make as much noise and smoke as possible?!"
Yes. Of course. Most of the time.

But there are times...

I was in an Imperial palace once, disguised as a servant. My assignment was to knock out the palace's security system in such a way that I could be out of the palace for three days before the system went down. I could have planted a bomb in the office of security for the palace, but that would have tipped them off to the upcoming Rebel raid. Instead, I used a "micronite" charge on a small wire within the office's computer system.

I picked the wire with two things in mind. First, I wanted a wire that would cripple the system. Second, I wanted it buried far enough behind a tangle of other wires that no one would spot the broken wire with a cursory glance.

I planted the charge and left, with the timer set for 72 hours. Three days later the system went down. They thought it was a problem with the software or the wiring because nothing big and flashy had happened.

I'm sure they checked the wires, but most people only check the connections. They seldom check the middle of the wire, which is where I'd done the damage.



BLASTER POWER PACK BOMB

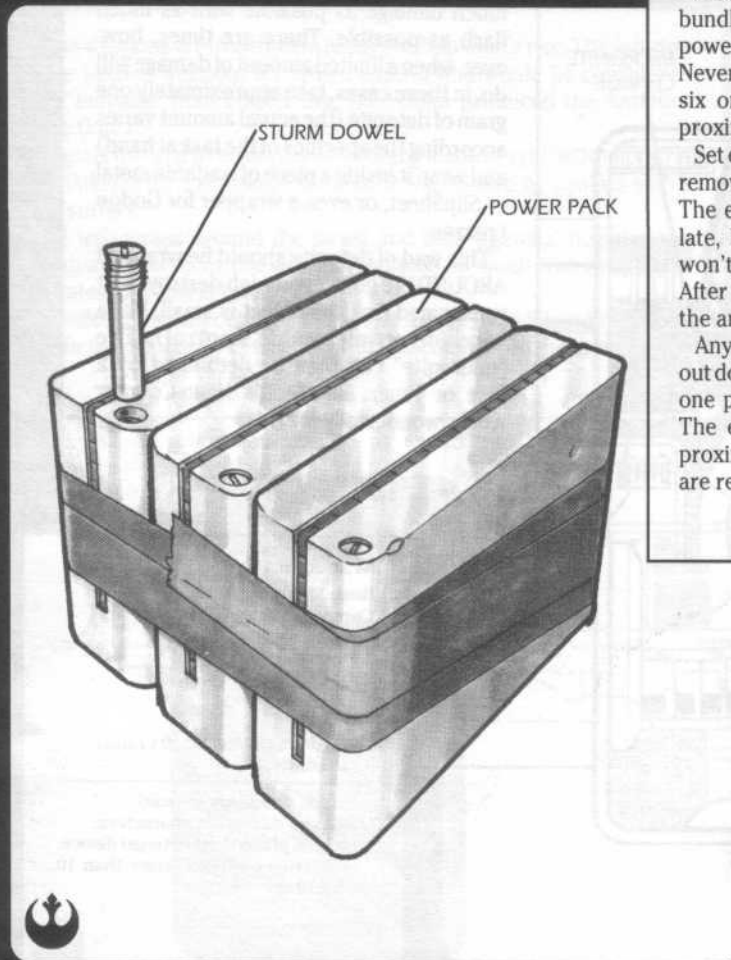

A bomb can be created by overloading a bundle of blaster power packs. Bind the power packs together, using wire or tape. Never use more than five packs, because six or more overloading packs in close proximity tend to blow up immediately.

Set each pack on maximum intensity, and remove each pack's Overload Sturm Dowel. The energy from each pack will accumulate, but with the dowel gone, the pack won't be able to safely disperse the energy. After the dowels are removed, get out of the area.

Any pack reaching critical charge without dowels will overload and blow up. Once one pack blows, it detonates the others. The explosion normally takes place approximately 30 seconds after the dowels are removed.

■ Specifications

Item: Blaster Power Pack Bomb

Components:

Several Power Packs

Tape

Scale: Character

Skill Code:

Build: Technology

Use: Grenade (when thrown)

Building Difficulty: Easy

Range:

Short: 3m to 7m

Medium: 8m to 20m

Long: 21m to 40m

Damage:

Figure As Grenade:

Point Blank: 1m to 2m

1D Per Power Pack

Short: 3m to 4m

-1D From Point Blank Damage

Medium: 5m to 6m

-2D From Point Blank Damage

Long: 7m to 10m

-3D From Point Blank Damage

The gamemaster should secretly roll one die. The result is the number of rounds until the explosion.

If the Rebel fails the *technology* roll to make the bomb, it blows up in his hands.

■ ADDENDUM/PERSONAL ■ CRACKEN, AIREN/GENERAL..

This kind of demolitions fooling around is often more dangerous for the person making the bomb than it is for the person it's intended for. Only try this if you don't have any loved ones waiting for you back home.

NEGATIVE POWER COUPLER/ POSITIVE FLOW DETONATOR

This powerful jury-rigged bomb is created by fusing the negative power coupler from a small starship with a positive flow detonator. To fuse the two devices, place the prong slot end of the detonator into the Garris socket of the coupler. The Garris socket of small starship couplers is close enough in size that it should provide a nice, tight fit. Once you've got the detonator in the coupling, the positive flow from the detonator will overheat the metal of the two devices, fusing them together. The build-up of power will drive both machines into a critical state and cause a tremendous explosion.

The bomb's flaw is that the explosion can take place instantly. There's no way around this, as the whole point of the device is that you're putting together two devices that should never have been put together.

■ Specifications

Item: Negative Power Coupler/
Positive Flow Detonator

Components:

Negative Power Coupler (from a small starship)
Positive Flow Detonator

Scale: Speeder

Skill Code:

Build: Technology

Building Difficulty: Very Difficult

Damage:

| | |
|------------------------------|----|
| <i>Point Blank:</i> 1m to 2m | 8D |
| <i>Short:</i> 3m to 4m | 6D |
| <i>Medium:</i> 5m to 6m | 4D |
| <i>Long:</i> 7m to 10m | 3D |

Cost:

Positive Flow Detonator: 100 Credits

Availability: R

If the *technology* roll fails, the bomb goes off instantly.

If the roll succeeds, the gamemaster secretly rolls one die. The result is the number of rounds before the bomb explodes.



POSITIVE FLOW
DETONATOR

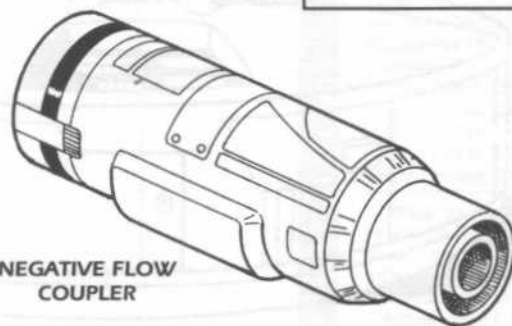

NEGATIVE FLOW
COUPLER

■ ADDENDUM/PERSONAL ■ CRACKEN, AIREN/GENERAL..

The origin of this bomb is a mystery to me. It's such an obviously bad idea to shove the live end of a positive flow detonator into the middle of a negative flow coupler I'm surprised anyone ever tried it.

Every starship carries spare couplers. Positive flow detonators, while not standard issue, can be bought off the black market in most cities on major worlds. The bomb is big, weighing over 40 kilograms, but its powerful enough to do just about any job.

This device, by the way, was how my men and I escaped a group of lizard men who captured us in a swamp. It turned out that their tribe was partially housed

in the remains of a stock light freighter that had crashed years earlier. Although they'd scoured the ship for equipment of obvious value, they'd left a great many items they couldn't figure out. While they prepared fires to cook us, we found a positive flow detonator in the storage room they'd housed us in. One of my men, a small, excitable fellow named Briggs, I think, travelled down a service tube and managed to rip the negative coupling out of the engine system. We drew lots to see who would try to blow open a hole in the ship's hull.

This man's name I remember. D'kar.

The rest of us escaped.

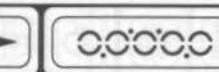

SOROSUUB XG ANTI-GRAVITY FIELD BOMBS

SoroSuub has created the XG anti-grav field bombs to take out light transport vehicles used in uprisings against Imperial forces. These mines can destroy landspeeders and low flying speeder bikes. The bombs are typically buried one half meter beneath the surface, and are detonated when a repulsorlift anti-grav field passes within three meters. Troops and non-repulsorlift vehicles can pass over the bombs without any problem.

■ Specifications

Weapon: SoroSuub XG Anti-Gravity Field Bombs

Type: Light Repulsor Mine

Scale: Speeder

Skill Code: Demolition

Damage

Point Blank: 1m to 2m 6D

Short: 3m to 4m 5D

Medium: 5m to 6m 3D

Long: 7m to 10m 2D

Availability: X

Cost: 400

Is triggered when any repulsor vehicles passes within 3 meters of it.

Can be disarmed with Moderate demolition roll. If roll fails, mine explodes.

REPULSOR SENSOR

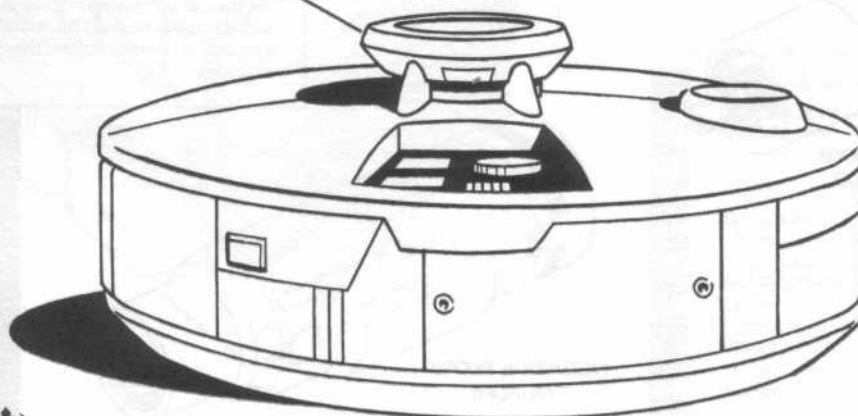

■ ADDENDUM/PERSONAL ■ CRACKEN, AIREN/GENERAL..

Although the Imperials use these devices as mines, I've found other uses for them. Once, I took a captured case of the bombs and snuck into an Imperial fortress. I found the vehicle depot and placed bombs in a dozen speeder bikes. When my forces attacked an hour later, the Imperials went running to their bikes — and caused a terrible racket when their vehicles blew up. The stormtroopers didn't know which way the attack was

coming from and we quickly stormed the area.

Something else to keep in mind. In order to keep local resistance forces weak, Imperials often round up all the vehicles in a town or village and impound them. To prevent vehicles from coming back, they lay bombs out in the streets. As long as only people walk the streets everything is fine. But should a vehicle buzz in...

← PREVIOUS

DATAPAGE: 78

NEXT →



☯ NORSAM DR-X55 IMPERIAL LIFT-MINE

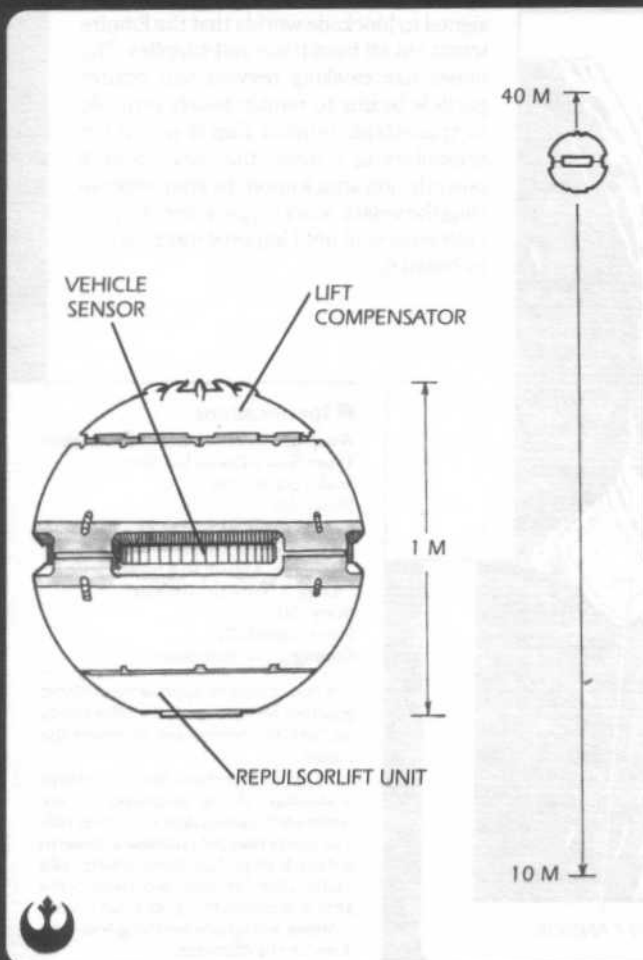

Imperial lift-mines are built with repulsorlifts that keep them floating above the surface of a planet. They can be set to float at a specific altitude, or float up and down between two pre-set altitudes. They are not capable of horizontal movement. The top of the line lift-mines, like the Norsam DR-X55, can detect enemy craft 100 meters away and adjust their altitude to intercept the vehicle.

The mines detonate when a vehicle passes within three meters of them. The Empire uses them primarily to blockade important mountain passes or other strategic areas. The mines are often used to complement artillery fortifications, although they can be used alone when heavy weapons are in short supply.

■ Specifications

Weapon: Norsam DR-X55

Type: Repulsorlift Mine

Scale: Speeder

Length: 1 m diameter

Speed Code: 2D

Maneuverability: 1D

Damage:

Point Blank: 1m to 5m 4D

Short: 6m to 10m 3D

Medium: 11m to 15m 2D

Long: 16m to 20m 1D

Flight Ceiling: 500 meters

Mines can be set for a specific height or to move between two heights. Mines move up to 250 meters per round, although soldiers can program them to rise and fall at slower speeds.

Mines detect vehicles up to 100 meters away. Once a target is detected, it will adjust its height to match that of the vehicle.

Detonates when a vehicle passes within 3 meters. Gamemaster should make map of mine field. When entering a mine field, the pilot must make a maneuver roll for every mine within 20 meters of his flight path (reflecting the adjustments and minute course alterations he will make during the round). Any mine that beats his roll explodes. Mines cannot be detonated by other mines. Mine fields often force pilots to make multiple maneuver rolls each round.

■ ADDENDUM/PERSONAL ■ CRACKEN, AIREN/GENERAL..

The mines are visible, so they are an effective deterrent. It is a strange sight to see a patch of sky filled with dark orbs calmly floating up and down.

Imperial policy is to set different mines at different altitude ranges. Thus, in a field of 100 mines, 40 might cover the air from one to 10 meters (to guard against land speeders and low-flying speeder bikes), 30 might cover the air from 11 to 25 meters (for high-flying speeder bikes) and the last 30 float between 26 to 40 meters, to block airspeeders or cloud cars coming in for low passes.

The worst thing about the Norsam DR-X55 is that they can move fairly quickly. When you're racing through the

field in your speeder and you see a mine dropping like a stone directly ahead — well, it's very disconcerting.



MERR-SONN DEFENDER ION MINES

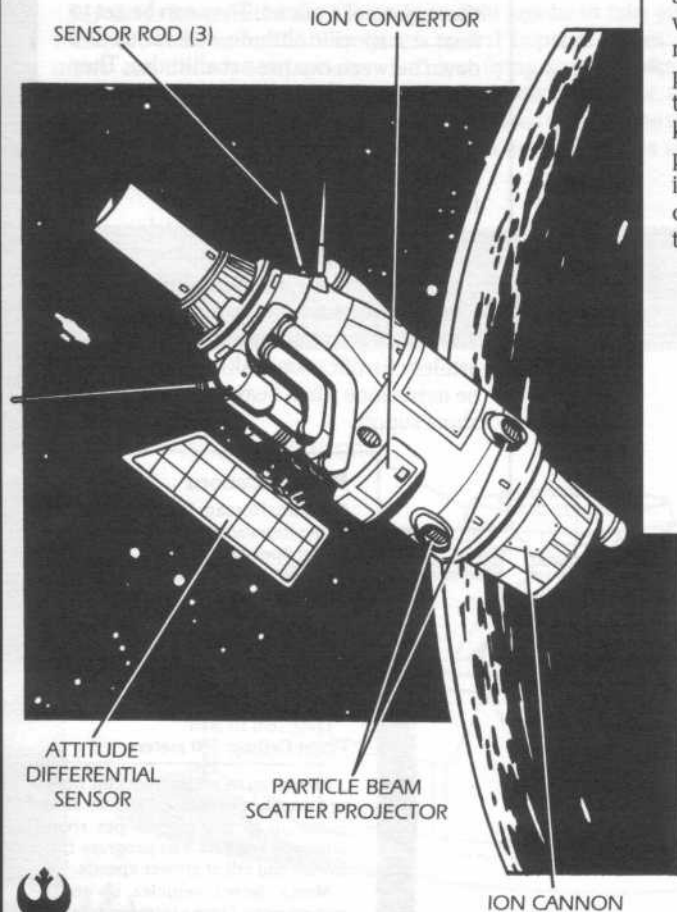

Merr-Sonn's Defender Ion Mines are designed to blockade worlds that the Empire wants cut off from trade and supplies. The mines use cloaking revvers and scatter particle beams to remain nearly invisible to spaceships. When a ship is within ten kilometers of a mine, the mine emits a powerful ion attack upon the ship, neutralizing the vessel. Stuck in space, the crippled craft must wait until Imperial forces arrive to board it.

■ Specifications

Weapon: Merr-Sonn Defender Ion Mine

Type: Space-Based Ion Mine

Scale: Starfighter

Skill Code: Scanning 5D

Range:

Short: 5m to 3,000m

Medium: 3,001m to 6,000m

Long: 6,001m to 10,000m

Body: 2D

Fire Control: 6D

Damage: 10D Ionization

When a ship first approaches a planet guarded by ion mines, the pilot needs an Easy *Mechanical* roll to detect the mines.

To avoid detection, the pilot makes a *starship piloting* maneuver action, while each mine makes a *scanning* roll. The mines may not combine actions to detect a ship. Any mine which rolls higher than the maneuver detects the ship and begins firing once per round.

Mines will ignore anything less than 4 meters in diameter.

■ ADDENDUM/PERSONAL ■ CRACKEN, AIREN/GENERAL..

When the Imperials blockade a planet, they scatter Defenders throughout the near space orbit of the world. It is nearly impossible to get through the blockade without encountering at least one of the mines.

Of course, there are times when a run through a blockade has to be tried. Early in the war, the Empire blockaded the world of Berason because of its political views. Berason is a low tech mining world that depended upon food and medical supplies from other planets in exchange for minerals. When their trade was

cut off the people became ill. The blockade began to weaken their resolve to work against the Empire.

I was put in charge of a force to get supplies to the world below — both food and military — and then lead a strike against the world's Imperial base. We got through the blockade by sending men out in vacc-suits and jet packs. They're small enough to avoid detection. It was a very slow process, but we cleared a path for our massive convoy.

STAR WARS®

Cracken's Rebel Field Guide

by Christopher Kubasik

Technology. Learn to use it or be used by it. In the Galactic Civil War, the Empire has all of the advantages. More troops. More weapons. Better equipment. The Rebel Alliance has to rely on the resourcefulness of its troops and their ability to make do with what is at hand.

Alliance General Airen Cracken, a decorated veteran of many battles, teaches Rebel soldiers how to survive in the field where the best weapon is one's wits. Cracken explains how to alter technology to the needs of the moment and increase the odds of survival despite cunning foes and hostile environments. The general provides complete information, much of it secret, concerning new weapons and tools for Rebel troops and their foes.

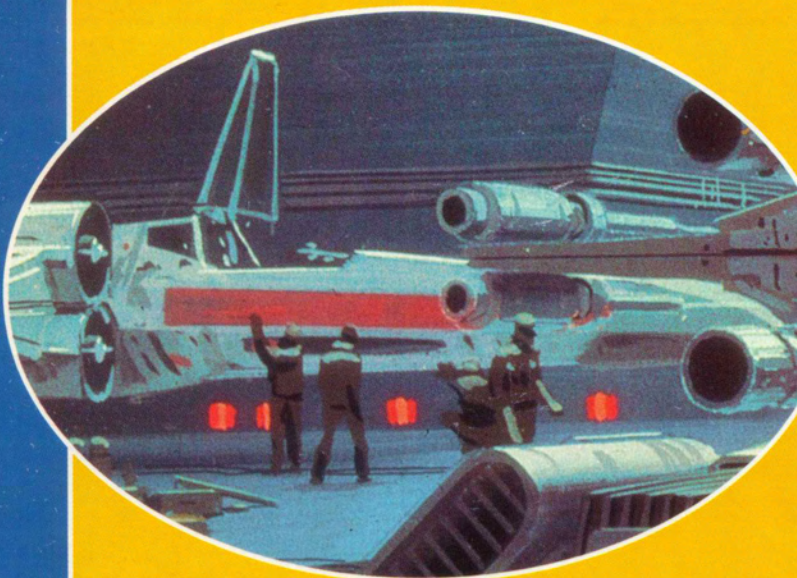

80-page book features:

- Numerous entries describing new equipment.
- Tips and rules for jury rigging devices for improved performance.
- Detailed technical illustrations that show Rebel troops how the devices work.
- Cyborg technology, as well as detailed rules for its use in the *Star Wars* universe.
- Computer data and artificial intelligence in the *Star Wars* universe.
- Complete game statistics for new and familiar weapons, vehicles and devices.

A supplement for *Star Wars: The Roleplaying Game*.
For ages 12 and up.

A **STAR WARS**
SUPPLEMENT



West End Games
RD 3 Box 2345
Honesdale, PA 18431

40046

©, ™ & © 1991 Lucasfilm, Ltd.
(LFL). All Rights Reserved.
Trademarks of LFL used by
West End Games under
authorization.

0-87431-118-7 \$13.00

